

4 | 3 | 2 | 1

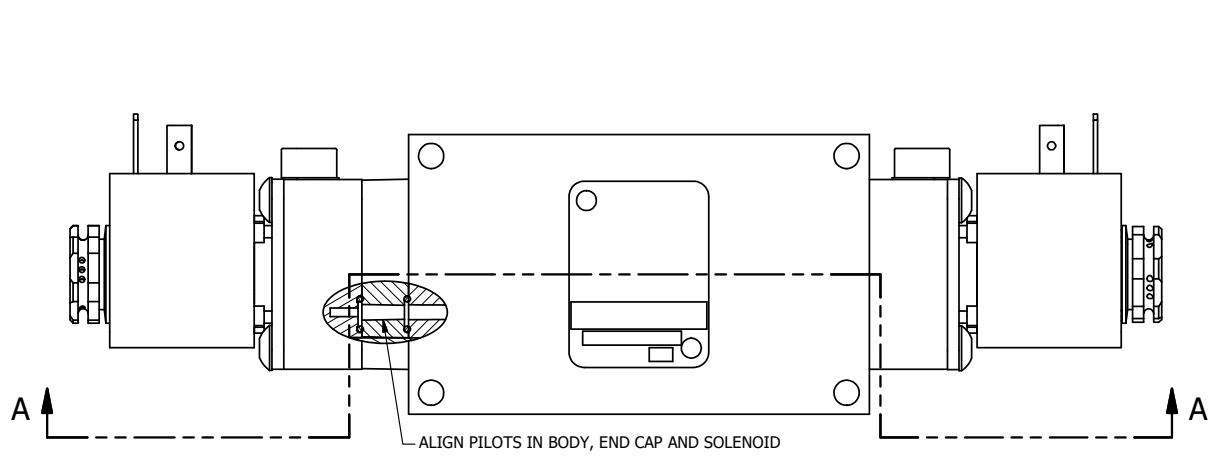

ALIGN PILOT AND SLOT IN ADAPTOR WITH GASKET IN BETWEEN, BOTH SIDES. FOR EXTERNAL PILOT OPERATION - ROTATE ADAPTOR 180 DEGREES. REMOVE 1/8" NPTF PLUG AND SUPPLY 50-150 PSI TO 1/8" NPTF PILOT PORT IN ADAPTOR.

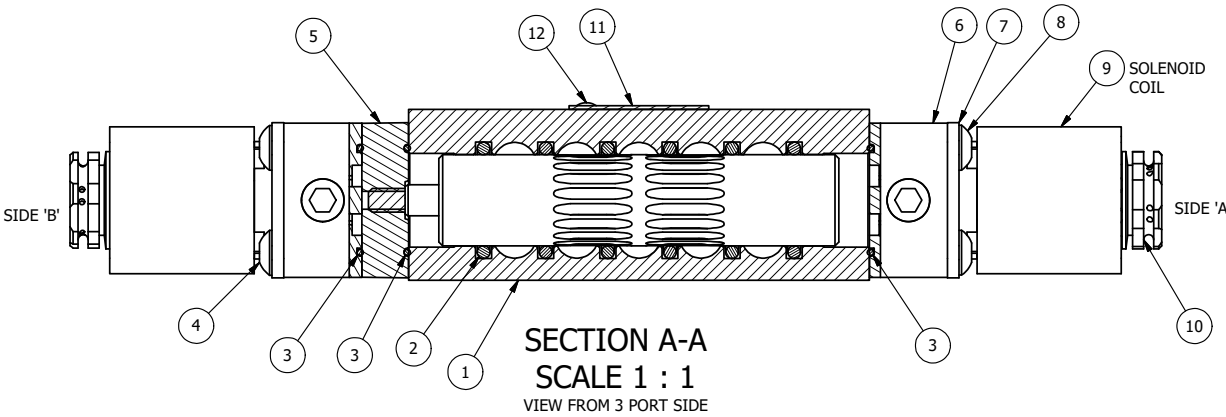

12	2	V-212	SCREW, #2 X 3/16 DRIVE, TYPE U, OVAL HEAD, STAINLESS STEEL
11	1	AN-114	NAMEPLATE, BLANK, FOR VALVES WITH SPRINGS OR DETENTS
10	2	V-562	NUT, SOLENOID, SIDE EXHAUST
9	2	V-603-1	COIL HI-TEMP. 8-30T 120/60. NASS # 0558 55.1-00/7121.
8	4	V-584	SCREW, 10-24 X 1, BUTTON HEAD SOCKET CAP WITH MICROSPHERE APPLIED TO THREADS.
7	2	SEC3-7	PLATE, RE-INFORCEMENT, SOLENOID, STAMPED, 304 STAINLESS
6	2	V-599-1	SOL OPER, END MOUNT, LOCKING O'RIDE
5	1	AY-EMY3D	ASSY - SPR CTR, REGEN CTR SPL, END MOUNT SOLENOID, 1/4" & 3/8" VALVES
4	4	V-601	SCREW, 10-24 X 1-1/2, BUTTON HEAD SOCKET CAP WITH MICROSPHERE ADHESIVE
3	3	EMG3	GASKET - END MOUNT SOLENOID, BUNA-N, 1/4" & 3/8" VALVES
2	6	V-39	O-RING, VITON, STD BODY, 1/4" & 3/8" VALVES
1	1	B2-1E	BODY - SOLID, BUTTON BLEEDER, ANODIZED, 1/4" SIDE PORT VALVE
FLG	QTY	PART NO	DESCRIPTION

NOTES:
 1) ALWAYS GIVE VALVE MODEL AND PART NUMBER WHEN ORDERING PARTS.
 2) FOR DIFFERENT VOLTAGES OTHER THAN 120/60, REPLACE SOLENOID COIL WITH COIL LISTED IN TABLE BELOW.

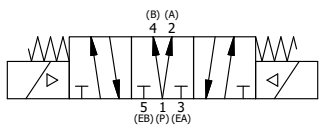

COIL VOLTAGES	
PART NO	REPLACE COIL
ESY2DHOC 12VDC	V-603-2

LIMITS ON DIMENSIONS UNLESS OTHERWISE SPECIFIED		2-PL DECIMAL ± .01 3-PL DECIMAL ± .005 FRACTIONAL ± 1/64 ANGULAR ± 1/2°		AAA PRODUCTS INTERNATIONAL 7114 Harry Hines Blvd Dallas, TX 75235
DRAWN: RMckenna	DATE: 6/24/2018	CHECKED: KWaite	DATE: 6/24/2018	
SCALE: 1 : 1	SHEET: 1 OF 1	RELEASED: HWomack	DATE: 6/24/2018	
TITLE: 1/4" SIDE PORT, DBL SOL, 3 POS, SPR CTR, REGEN CTR SPL, H-TEMP, 120/60, LOCKNG OVRD, SIDE VENT		PART NO.: ESY2DHOC	REV.: A	

A	6/1/2018	ECG3 GASKET TO EMG3, CHNGD END CAP GEOM.
NO.	DATE	REVISION

4 | 3 | 2 | 1

THE INFORMATION CONTAINED WITHIN THIS DOCUMENT IS PROPRIETARY TO AAA PRODUCTS AND MAY NOT BE DISCLOSED WITHOUT PRIOR WRITTEN CONSENT

P:\Engineering\product\Valves\AssemblyStandards\ESY2DHOC.dwg