

POSITION GASKET AND AY-EMY3D ON END OF VALVE TO ALIGN PILOT HOLES (SIDE 'B' ONLY)



POSITION GASKET ON END OF VALVE BETWEEN BODY OR AY-EMY3D AND SOLENOID OPERATOR BOTH SIDES (SIDE 'A' SHOWN)



NOTES:
1) ALWAYS GIVE VALVE MODEL AND PART NUMBER WHEN ORDERING PARTS.

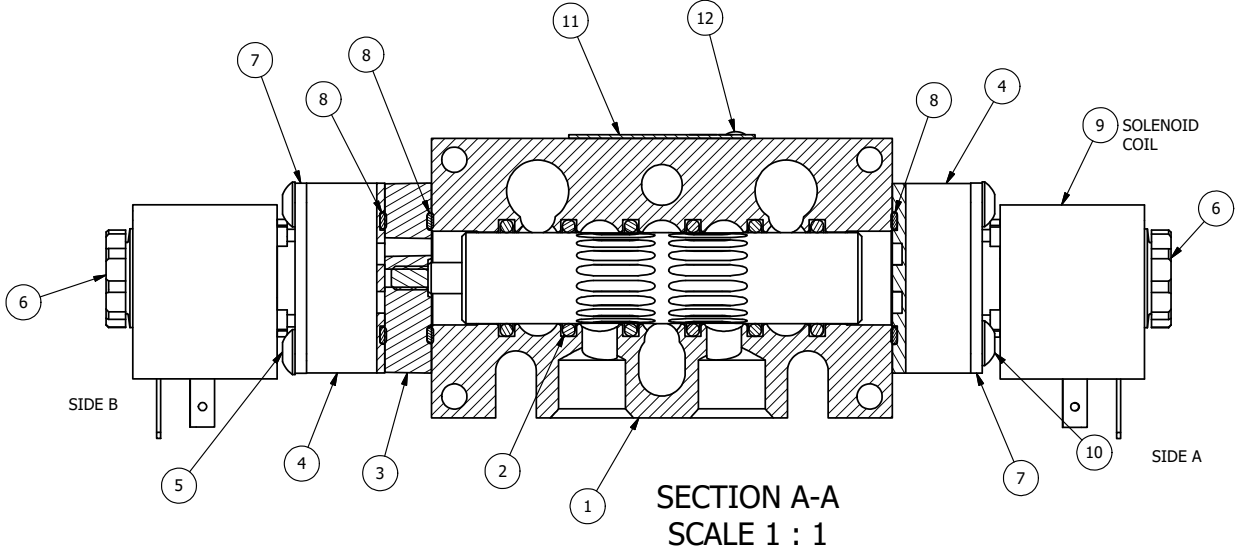

FLG	QTY	PART NO	DESCRIPTION
13	3	V-110	O-RING, BUNA-N, 70 DURO, AS-114, (REF 5/8 X 13/16 X 3/32), 1/4" SLEEVE, 1/2" SUB, STACK
12	2	V-212	SCREW, #2 X 3/16 DRIVE, TYPE U, OVAL HEAD, STAINLESS STEEL
11	1	AN-114	NAMEPLATE, BLANK, FOR VALVES WITH SPRINGS OR DETENTS
10	4	V-584	SCREW, 10-24 X 1, BUTTON HEAD SOCKET CAP WITH MICROSPHERE APPLIED TO THREADS.
9	2	V-603-1	COIL HI-TEMP. 8-30T 120/60. NASS # 0558 55.1-00/7121.
8	3	EMG3	GASKET - END MOUNT SOLENOID, BUNA-N, 1/4" & 3/8" VALVES
7	2	SEC3-7	PLATE, RE-INFORCEMENT, SOLENOID, STAMPED, 304 STAINLESS
6	2	V-556	NUT, SOLENOID, TOP EXHAUST, KNURLED
5	4	V-601	SCREW, 10-24 X 1-1/2, BUTTON HEAD SOCKET CAP WITH MICROSPHERE ADHESIVE
4	2	V-550-1	SOL OPER, END MOUNT, NON-LOCKING O'RIDE
3	1	AY-EMY3D	ASSY - SPR CTR, REGEN CTR SPL, END MOUNT SOLENOID, 1/4" & 3/8" VALVES
2	6	V-39	O-RING, VITON, STD BODY, 1/4" & 3/8" VALVES
1	1	B3-10E	FINISHED - SOLID BODY, UPPER PILOTS, 3/8" STACKING VALVE

LIMITS ON DIMENSIONS UNLESS OTHERWISE SPECIFIED
2-PL DECIMAL ± .01
3-PL DECIMAL ± .005
FRACTIONAL ± 1/64
ANGULAR ± 1/2°



DRAWN: RMckenna DATE: 11/3/2015 CHECKED: KWaite DATE: 11/3/2015
SCALE: 1 : 1 SHEET: 1 OF 1 RELEASED: HWomack DATE: 11/3/2015

TITLE: 3/8" STACK, DBL SOL, 3 POS, SPR CTR, SOL SHFT, REGEN CTR SPL, HIGH TEMP, 120/60	PART NO.: EBSY3DH	REV.: A
---	----------------------	------------

COIL VOLTAGES	
PART NO	REPLACE COIL
EBSY3DH 12VDC	V-603-2

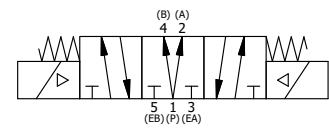

A	NO.	DATE	REVISION
	6/1/2018	ECG3 GASKET TO EMG3, SPL ASSY TO AY-EMY3D.	

THE INFORMATION CONTAINED WITHIN THIS DOCUMENT IS PROPRIETARY TO AAA PRODUCTS AND MAY NOT BE DISCLOSED WITHOUT PRIOR WRITTEN CONSENT