

NOTES:
1) ALWAYS GIVE VALVE MODEL AND PART NUMBER WHEN ORDERING PARTS.

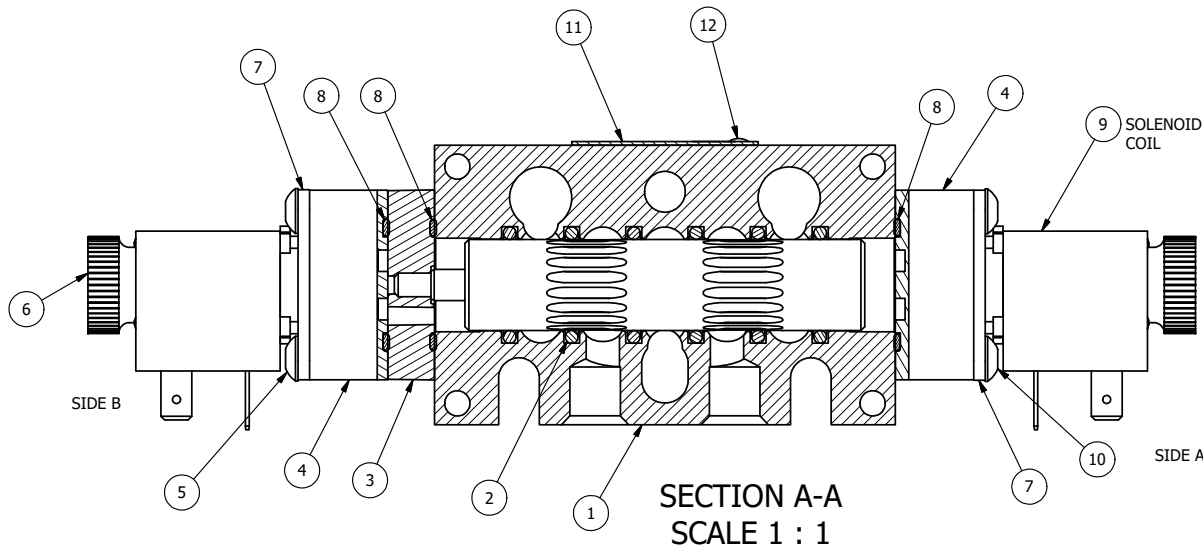

FLG	QTY	PART NO	DESCRIPTION
13	3	V-110	O-RING, BUNA-N, 70 DURO, AS-114, (REF 5/8 X 13/16 X 3/32), 1/4" SLEEVE, 1/2" SUB, STACK
12	2	V-212	SCREW, #2 X 3/16 DRIVE, TYPE U, OVAL HEAD, STAINLESS STEEL
11	1	AN-114	NAMEPLATE, BLANK, FOR VALVES WITH SPRINGS OR DETENTS
10	4	V-584	SCREW, 10-24 X 1, BUTTON HEAD SOCKET CAP WITH MICROSPHERE APPLIED TO THREADS.
9	2	V-551-1	THERMOPLASTIC ENCAPSULATED COIL 120V 50/60HZ, NASS P/N # 108-030-0455
8	3	EMG3	GASKET - END MOUNT SOLENOID, BUNA-N, 1/4" & 3/8" VALVES
7	2	SEC3-7	PLATE, RE-INFORCEMENT, SOLENOID, STAMPED, 304 STAINLESS
6	2	V-567W	E SERIES SINTERED BRONZE MUFFLER, DUST EXCLUDER, V-613 LOCK WASHER
5	4	V-601	SCREW, 10-24 X 1-1/2, BUTTON HEAD SOCKET CAP WITH MICROSPHERE ADHESIVE
4	2	V-550-1	SOL OPER, END MOUNT, NON-LOCKING O'RIDE
3	1	AY-EMY3G	ASSY - SPR CTR, OPEN CTR SPL, END MOUNT SOLENOID, 1/4" & 3/8" VALVES
2	6	V-39	O-RING, VITON, STD BODY, 1/4" & 3/8" VALVES
1	1	B2-10E	FINISHED - SOLID BODY, UPPER PILOTS, 1/4" STACKING VALVE

LIMITS ON DIMENSIONS
UNLESS OTHERWISE SPECIFIED
2-PL DECIMAL ± .01
3-PL DECIMAL ± .005
FRACTIONAL ± 1/64
ANGULAR ± 1/2°



DRAWN: RMckenna DATE: 5/12/2019 CHECKED: KWaite DATE: 5/12/2019
SCALE: 1 : 1 SHEET: 1 OF 1 RELEASED: HWomack DATE: 5/12/2019

COIL VOLTAGES	
PART NO	REPLACE COIL
EBSY2GLZ 12 VDC	V-551-2
EBSY2GLZ 24VDC	V-551-3
EBSY2GLZ 240/60	V-551-4

TITLE:
1/4" STACK, DBL SOL, 3 POS,
SPR CTR, SOL SHFT, FLOAT CTR SPL,
120/60, DUST EXCLDR, EXT PILOT

PART NO.:
EBSY2GLZ
REV.:
A

A	NO.	DATE	REVISION
	6/1/2018	ECG3 GASKET TO EMG3, SPL ASSY TO AY-EMY3.	

THE INFORMATION CONTAINED WITHIN THIS DOCUMENT IS PROPRIETARY TO AAA PRODUCTS AND MAY NOT BE DISCLOSED WITHOUT PRIOR WRITTEN CONSENT