

4 3 2 1

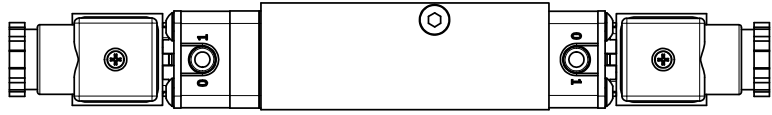

3/8" CORD GRIP DIN CAP INCLUDED
FORM A, ACC. TO EN 175301-803,
ISO 4400

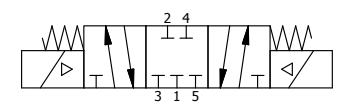
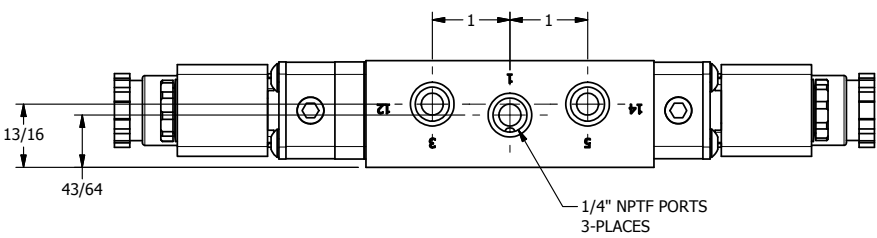
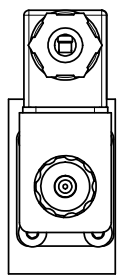
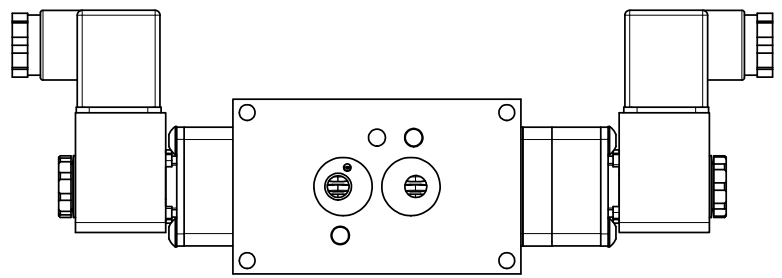
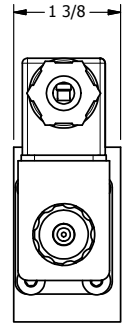
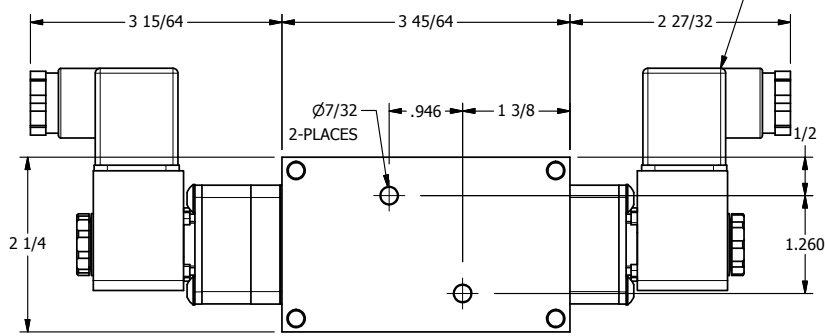

4 3 2 1

AAA
PRODUCTS
INTERNATIONAL
AAA PRODUCTS
INTERNATIONAL
7114 Harry Hines Blvd
Dallas, TX 75235

TITLE: 1/4" NAMUR, SNGL SOL, 3 POS,
SPR CTR, SOL SHFT, CLSD CTR SPL,
BRASS & SS, INTR SAFE, 24VDC

DRAWING NO.:
DIM_ZNSY2A

THE INFORMATION CONTAINED WITHIN THIS DOCUMENT IS PROPRIETARY TO AAA PRODUCTS AND MAY NOT BE DISCLOSED WITHOUT PRIOR WRITTEN CONSENT