

4

3

2

1

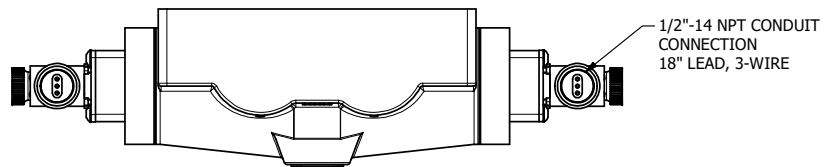

1/2"-14 NPT CONDUIT CONNECTION
18" LEAD, 3-WIRE

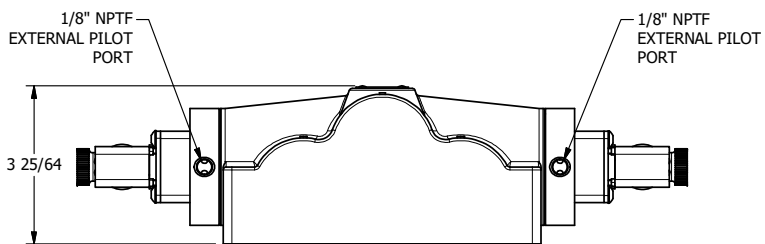
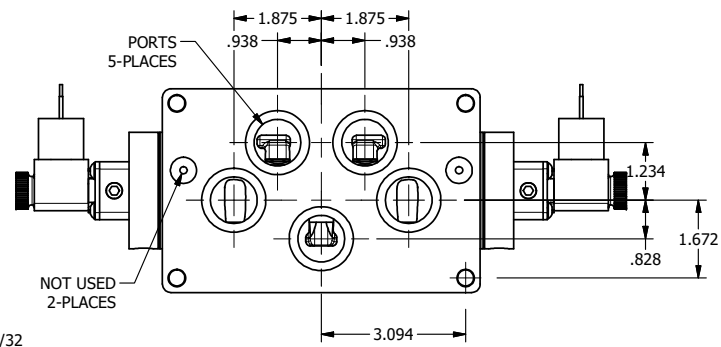
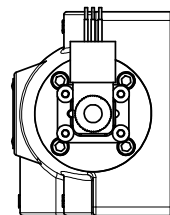
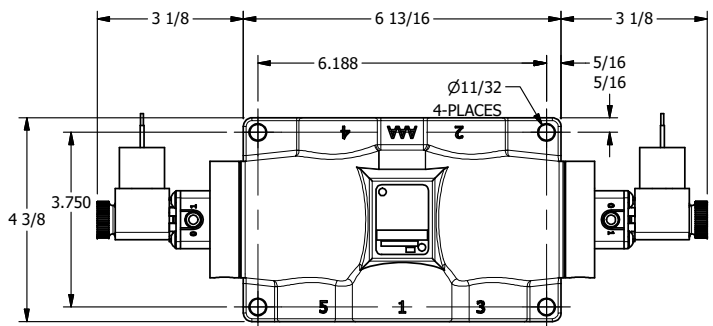
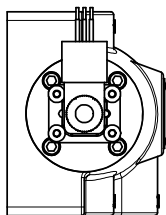

1/8" NPTF EXTERNAL PILOT PORT

1/8" NPTF EXTERNAL PILOT PORT

3 25/64

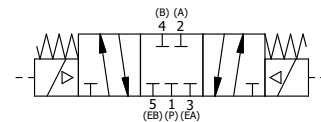

AAA
PRODUCTS
INTERNATIONAL

AAA PRODUCTS INTERNATIONAL
7114 Harry Hines Blvd
Dallas, TX 75235

TITLE: 1" SIDE PORT, DBL SOL, 3 POS,
CLSD SPR CTR, MOLD-OVER,
DUST EXCLDR, EXT PILOT

DRAWING NO.:
DIM_ESY8PJLZ

THE INFORMATION CONTAINED WITHIN THIS DOCUMENT IS PROPRIETARY TO AAA PRODUCTS AND MAY NOT BE DISCLOSED WITHOUT PRIOR WRITTEN CONSENT

4

3

2

B

B

A

A