

4

3

2

1

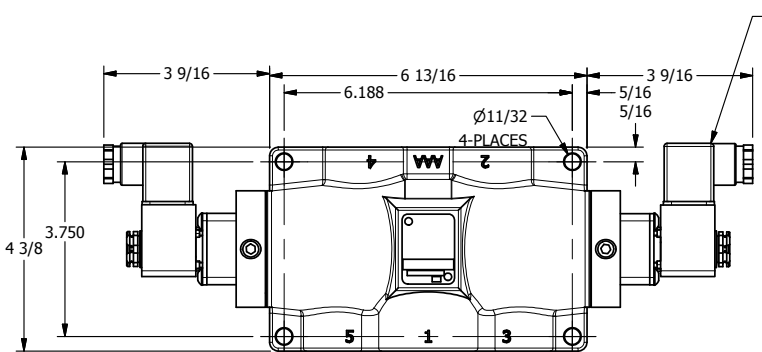
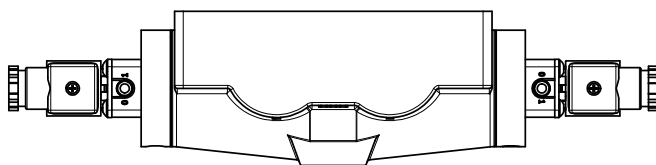

3/8" CORD GRIP DIN CAP INCLUDED
FORM A, ACC. TO EN 175301-803,
ISO 4400

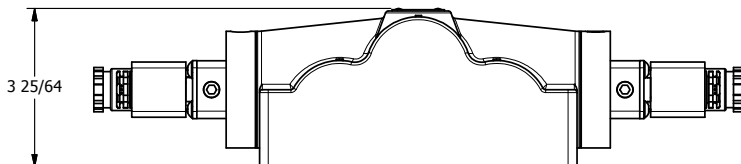
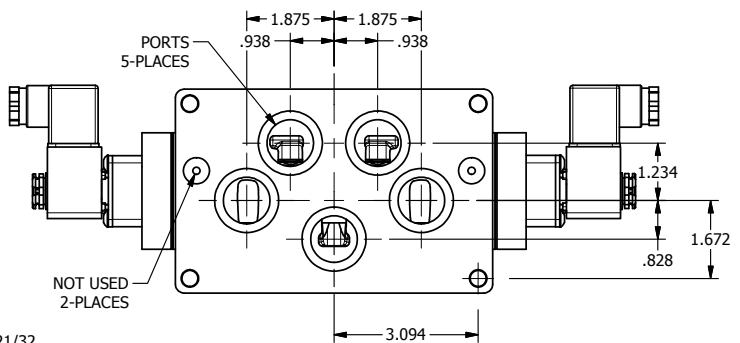
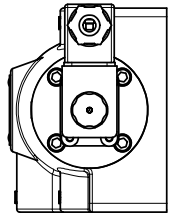
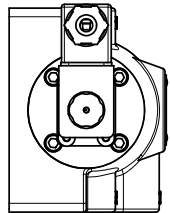

3 25/64

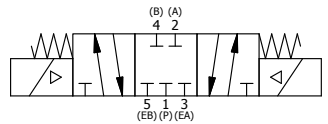

AAA PRODUCTS INTERNATIONAL
7114 Harry Hines Blvd
Dallas, TX 75235

**TITLE: 1" SIDE PORT, DBL SOL, 3 POS,
SPR CTR, SOL SHFT, CLSD CTR SPL,
INTR SAFE, 24VDC, SIDE VENT**

DRAWING NO.:
DIM_ESY8PAC

THE INFORMATION CONTAINED WITHIN THIS DOCUMENT IS PROPRIETARY TO AAA PRODUCTS AND MAY NOT BE DISCLOSED WITHOUT PRIOR WRITTEN CONSENT

4

3

2

1

B

B

A

A