

4 3 2 1

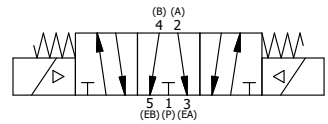
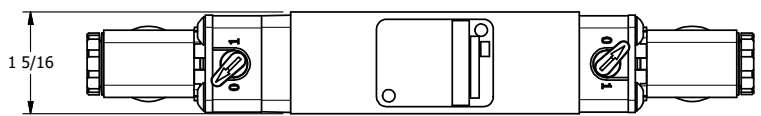
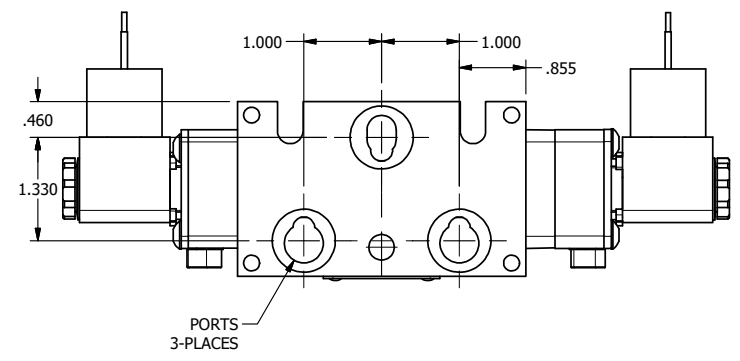
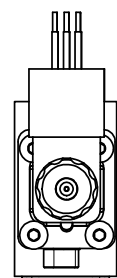
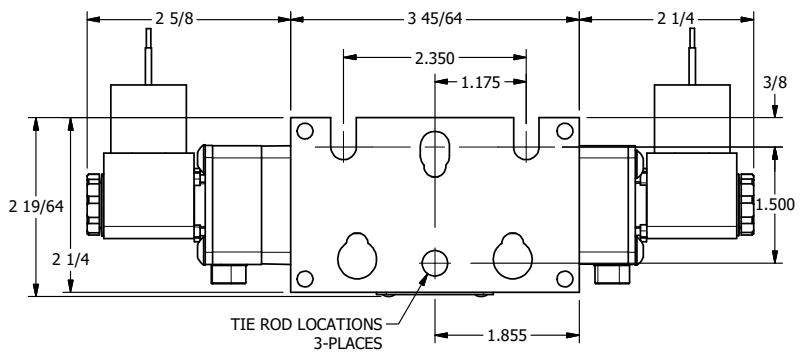
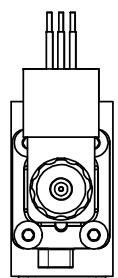
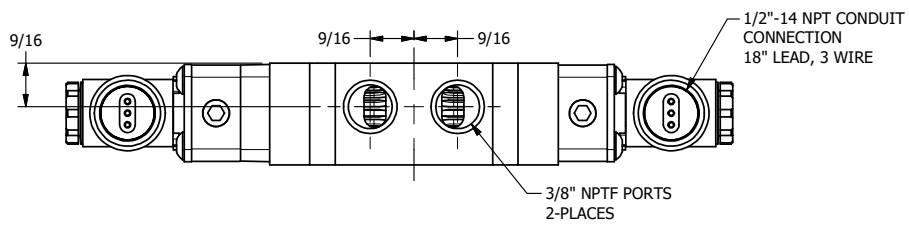

B

B

A

A

A

A

4 3 2 1



TITLE: 3/8" STACK, DBL SOL, 3 POS,
SPR CTR, SOL SHFT, FLOAT CTR SPL,
MOLD-OVER, LCKNG OVRD

DRAWING NO.:
DIM_EBSY3GJO

THE INFORMATION CONTAINED WITHIN THIS DOCUMENT IS PROPRIETARY TO AAA PRODUCTS AND MAY NOT BE DISCLOSED WITHOUT PRIOR WRITTEN CONSENT