

4

3

2

1

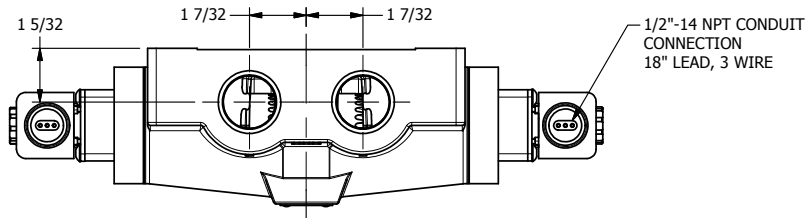

1/2"-14 NPT CONDUIT CONNECTION
18" LEAD, 3 WIRE

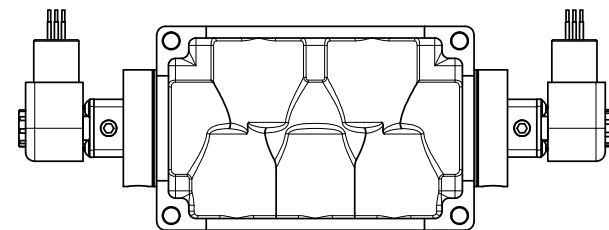
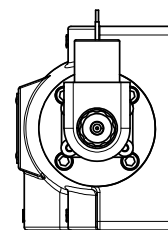
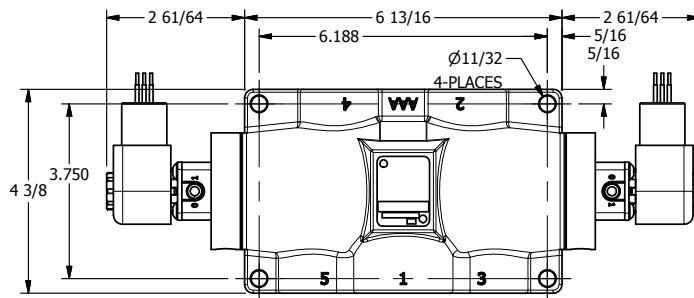
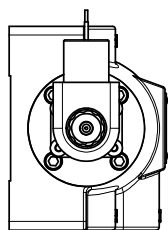

1 21/32

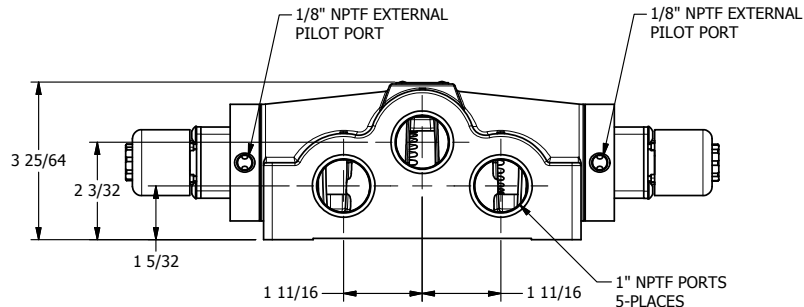

1/8" NPTF EXTERNAL PILOT PORT

1/8" NPTF EXTERNAL PILOT PORT

1" NPTF PORTS
5-PLACES

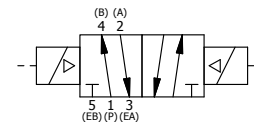

AAA
PRODUCTS
INTERNATIONAL
AAA PRODUCTS INTERNATIONAL
7114 Harry Hines Blvd
Dallas, TX 75235

TITLE: 1" SIDE PORT, DBL SOL, 2 POS,
FRICTION POS, SOL RTRN,
EXPL PROOF, EXT PILOT

DRAWING NO.:
DIM_ESS8XZ

4

3

2

1

THE INFORMATION CONTAINED WITHIN THIS DOCUMENT IS PROPRIETARY TO AAA PRODUCTS AND MAY NOT BE DISCLOSED WITHOUT PRIOR WRITTEN CONSENT