

4

3

2

1

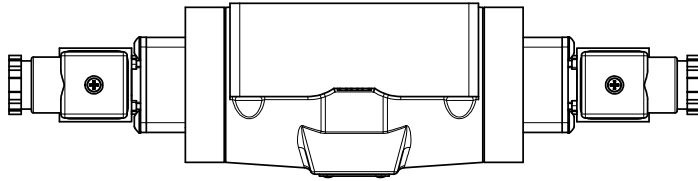

3/8" CORD GRIP DIN CAP INCLUDED
FORM A, ACC. TO EN 175301-803,
ISO 4400

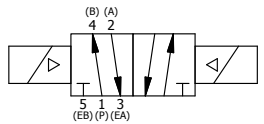
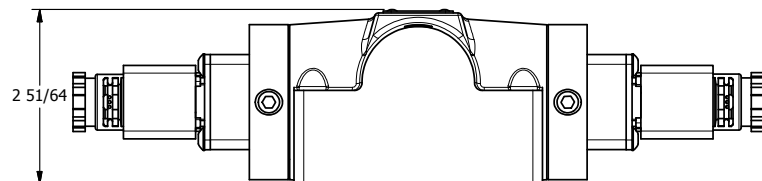
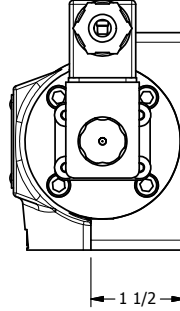
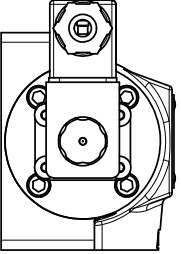
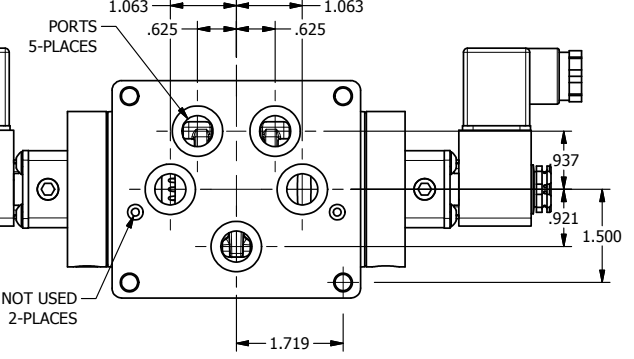
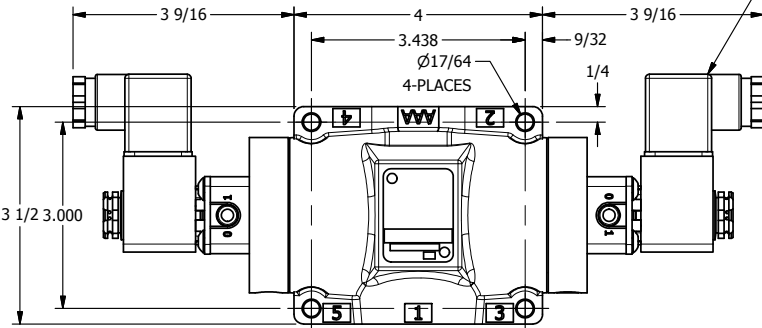

4

3

2

1

AAA
PRODUCTS
INTERNATIONAL

**AAA PRODUCTS
INTERNATIONAL**
7114 Harry Hines Blvd
Dallas, TX 75235

TITLE: 1/2" SUBPLATE, DBL SOL, 2 POS,
FRICTION POS, SOL RTRN,
INTR SAFE, 24VDC, SIDE VENT

DRAWING NO.:
DIM_ESS4PAC

THE INFORMATION CONTAINED WITHIN THIS DOCUMENT IS PROPRIETARY TO AAA PRODUCTS AND MAY NOT BE DISCLOSED WITHOUT PRIOR WRITTEN CONSENT