

4

3

2

1

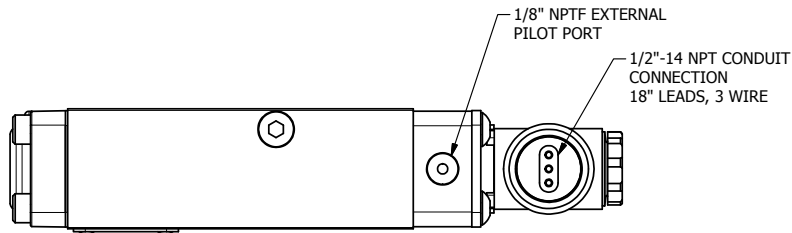

1/8" NPTF EXTERNAL PILOT PORT

1/2"-14 NPT CONDUIT CONNECTION  
18" LEADS, 3 WIRE

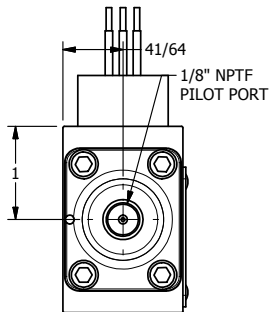

41/64

1/8" NPTF PILOT PORT

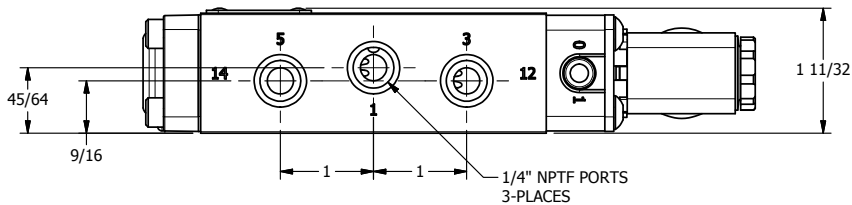
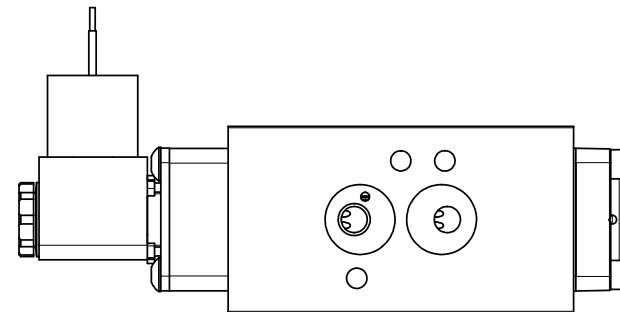
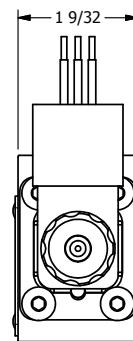
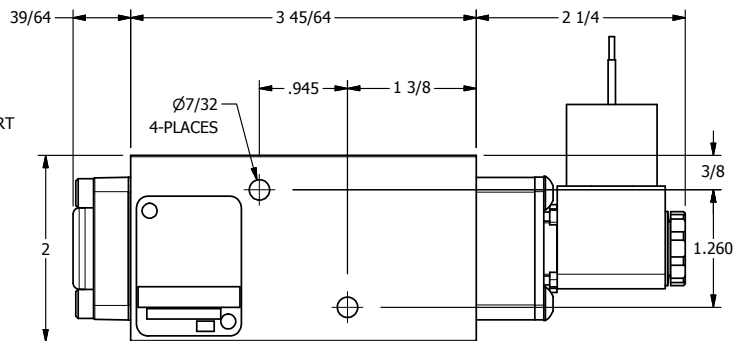

1/4" NPTF PORTS  
3-PLACES

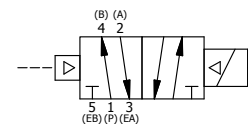

**AAA**  
PRODUCTS  
INTERNATIONAL

**AAA PRODUCTS INTERNATIONAL**  
7114 Harry Hines Blvd  
Dallas, TX 75235

TITLE: 1/4" NAMUR, SNGL SOL, 2 POS,  
FRICTION POS, PILOT RETURN,  
MOLD-OVER, EXT PILOT

DRAWING NO.:  
DIM\_NSR2JZ

THE INFORMATION CONTAINED WITHIN THIS DOCUMENT IS PROPRIETARY TO AAA PRODUCTS AND MAY NOT BE DISCLOSED WITHOUT PRIOR WRITTEN CONSENT

4

3

2

1