

4

3

2

1

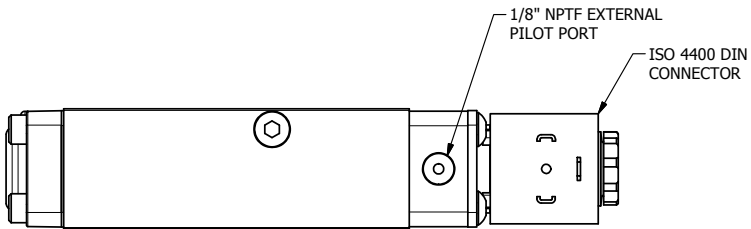

1/8" NPTF EXTERNAL PILOT PORT
ISO 4400 DIN CONNECTOR

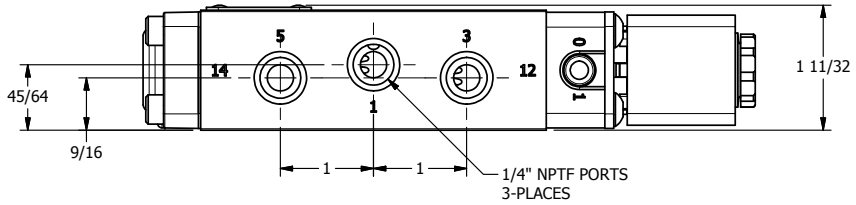
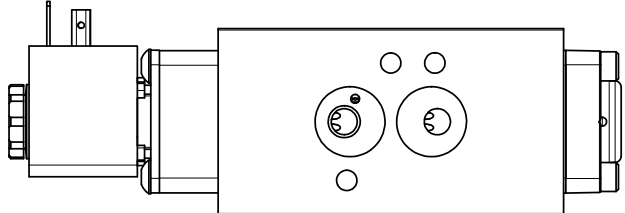
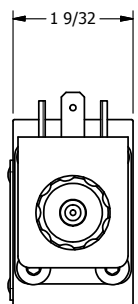
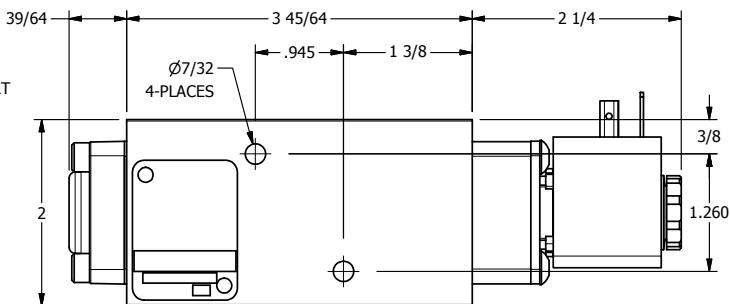
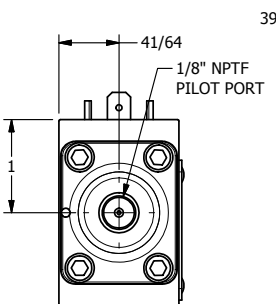

1/4" NPTF PORTS
3-PLACES

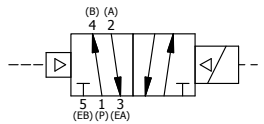

AAA
PRODUCTS
INTERNATIONAL
AAA PRODUCTS
INTERNATIONAL
7114 Harry Hines Blvd
Dallas, TX 75235

TITLE: 1/4" NAMUR, SNGL SOL, 2 POS,
FRICTION POS, PILOT RETURN,
HIGH TEMP COIL, EXT PILOT

DRAWING NO.:
DIM_NSR2HZ

4

3

2

1

THE INFORMATION CONTAINED WITHIN THIS DOCUMENT IS PROPRIETARY TO AAA PRODUCTS AND MAY NOT BE DISCLOSED WITHOUT PRIOR WRITTEN CONSENT