

4

3

2

1

1/8" NPTF EXTERNAL PILOT PORT
ISO 4400 DIN CONNECTOR

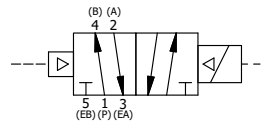
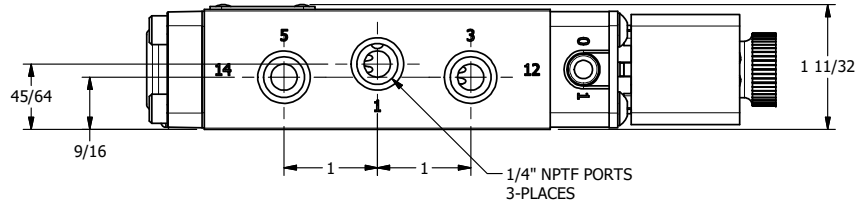
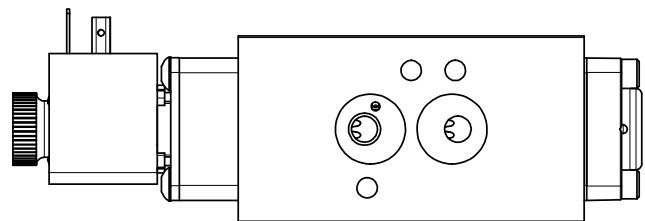
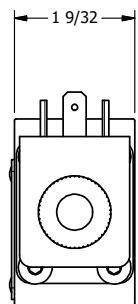
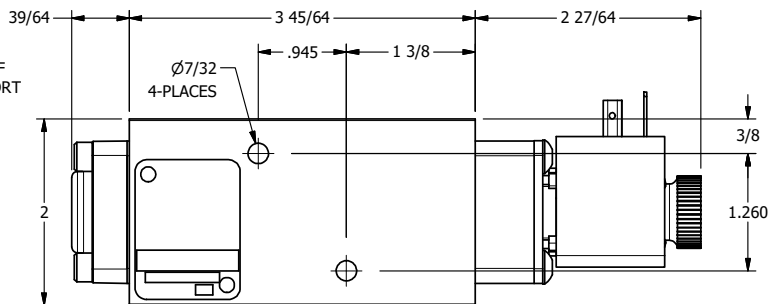
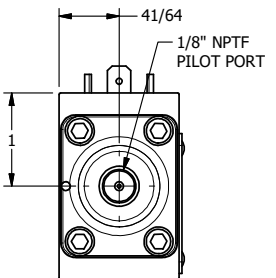
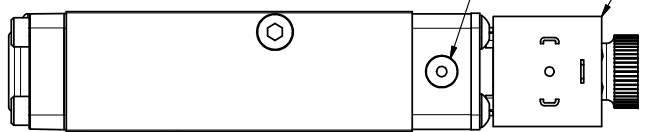

AAA
PRODUCTS
INTERNATIONAL

AAA PRODUCTS INTERNATIONAL
7114 Harry Hines Blvd
Dallas, TX 75235

TITLE: 1/4" NAMUR, SNGL SOL, 2 POS,
PILOT RTRN, HIGH TEMP COIL,
DUST EXCLDR, EXT PILOT

DRAWING NO.:
DIM_NSR2HLZ

4

3

2

THE INFORMATION CONTAINED WITHIN THIS DOCUMENT IS PROPRIETARY TO AAA PRODUCTS AND MAY NOT BE DISCLOSED WITHOUT PRIOR WRITTEN CONSENT