

4 3 2 1

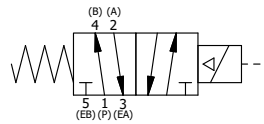

4 3 2

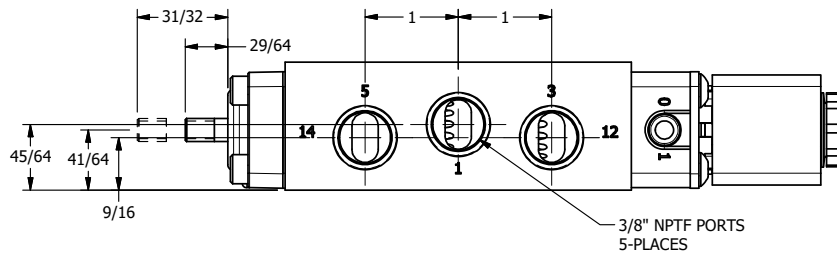
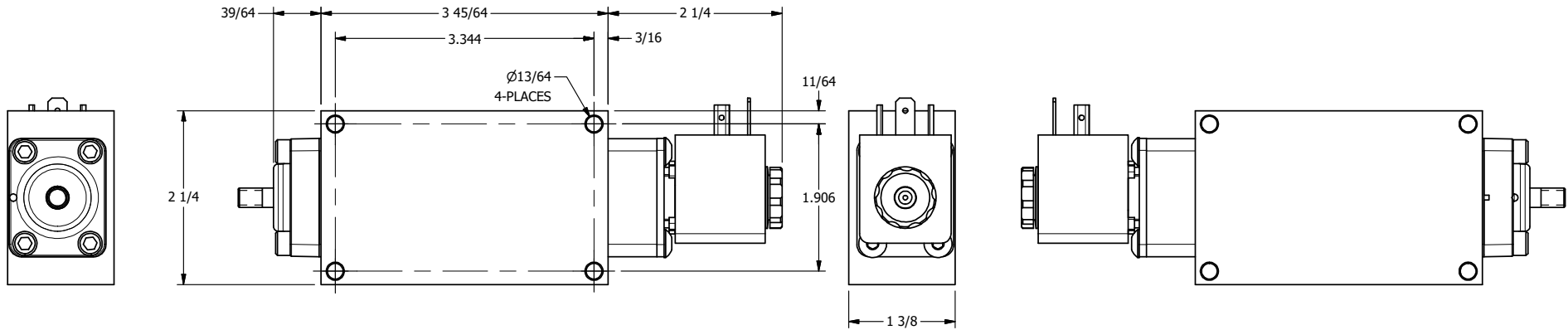
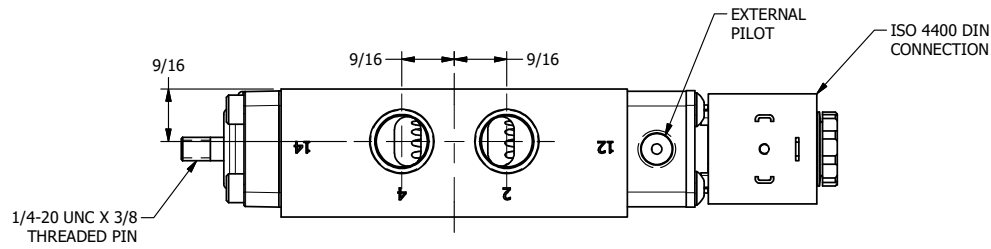

TITLE: 3/8" SIDE PORT, SNGL SOL, 2 POS,
SPR RTRN, H-TMP COIL, BR/SS,
THREADED INDCTR PIN, EXT PILOT

DRAWING NO.:
DIM_ZESO3HKZ

THE INFORMATION CONTAINED WITHIN THIS DOCUMENT IS PROPRIETARY TO AAA PRODUCTS AND MAY NOT BE DISCLOSED WITHOUT PRIOR WRITTEN CONSENT