

4

3

2

1

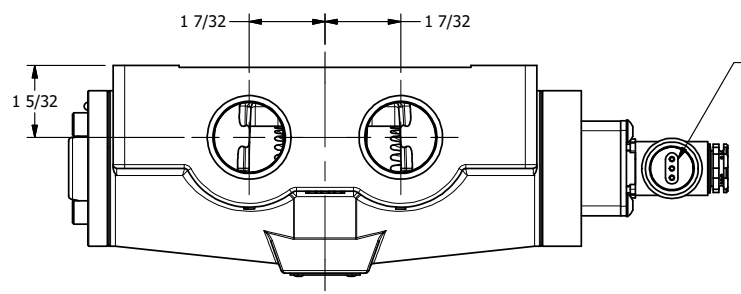

1/2"-14 NPT CONDUIT CONNECTION  
18" LEAD, 3 WIRE

B

B

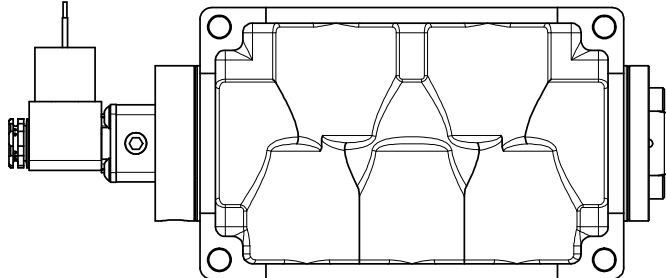
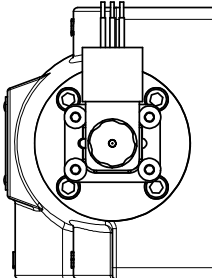
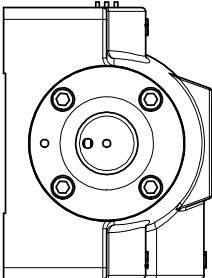
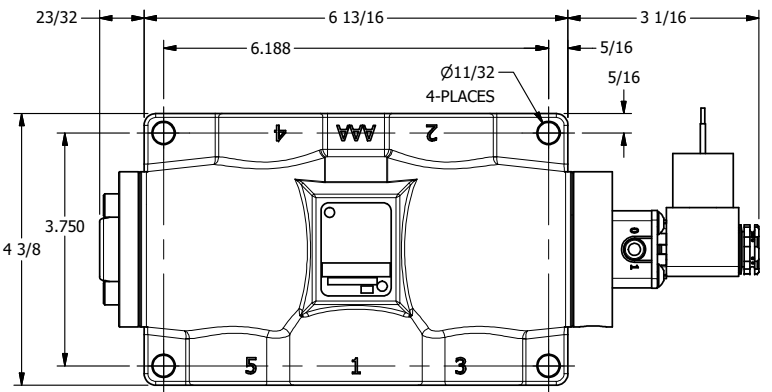

A

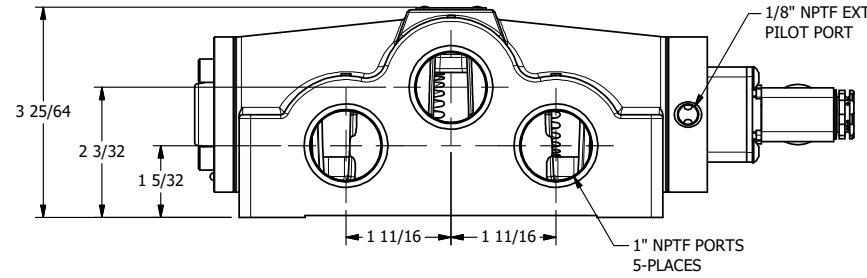

1/8" NPTF EXTERNAL PILOT PORT

1" NPTF PORTS  
5-PLACES

A

A

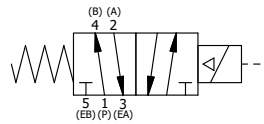

**AAA**  
PRODUCTS  
INTERNATIONAL

**AAA PRODUCTS INTERNATIONAL**  
7114 Harry Hines Blvd  
Dallas, TX 75235

TITLE: 1" SIDE PORT, SNGL SOL, 2 POS,  
SPR RTRN, MOLD-OVER,  
SIDE VENT, EXT PILOT

DRAWING NO.:  
DIM\_ES08JCZ

4

3

2



THE INFORMATION CONTAINED WITHIN THIS DOCUMENT IS PROPRIETARY TO AAA PRODUCTS AND MAY NOT BE DISCLOSED WITHOUT PRIOR WRITTEN CONSENT