

4

3

2

1

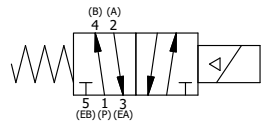
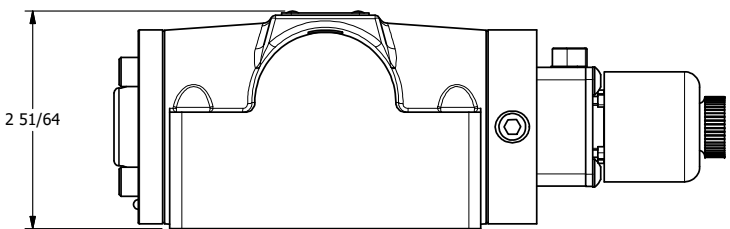
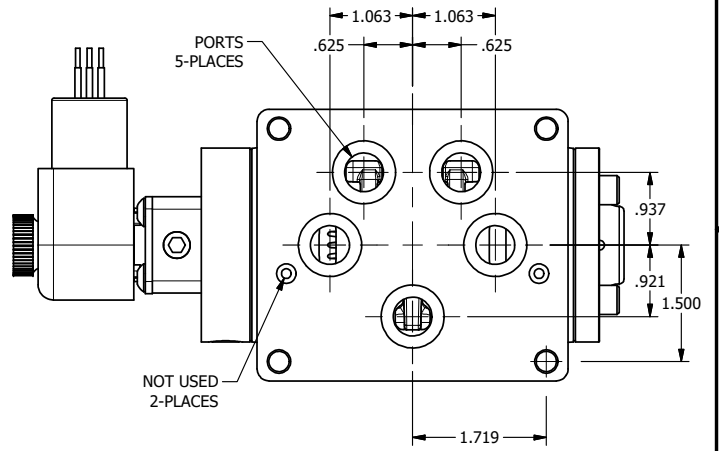
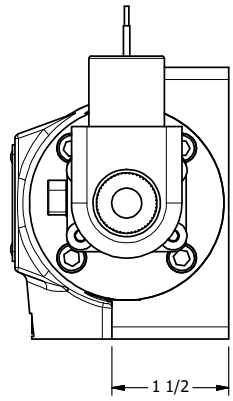
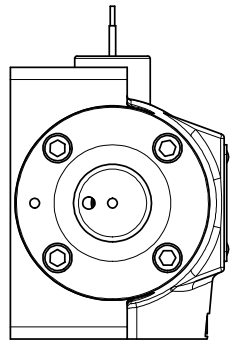
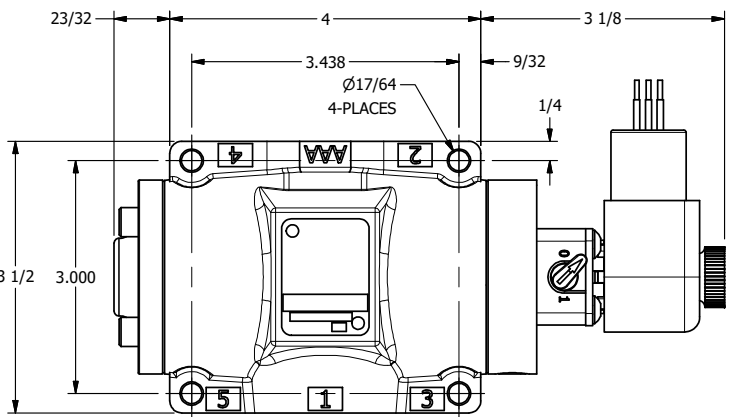
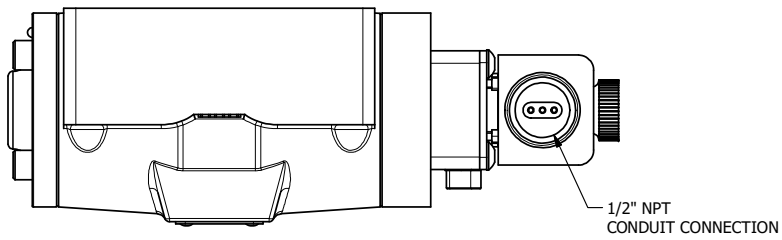

AAA
PRODUCTS
INTERNATIONAL

**AAA PRODUCTS
INTERNATIONAL**
7114 Harry Hines Blvd
Dallas, TX 75235

TITLE: 1/2" SUBPLATE, SNGL SOL, 2 POS,
SPRING RTRN, EXPLOSION PROOF,
LCKNG OVRD, DUST EXCLDR

DRAWING NO.:
DIM_ESO4PXOL

THE INFORMATION CONTAINED WITHIN THIS DOCUMENT IS PROPRIETARY TO AAA PRODUCTS AND MAY NOT BE DISCLOSED WITHOUT PRIOR WRITTEN CONSENT

4

3

2

B

B

A

A