

4

3

2

1

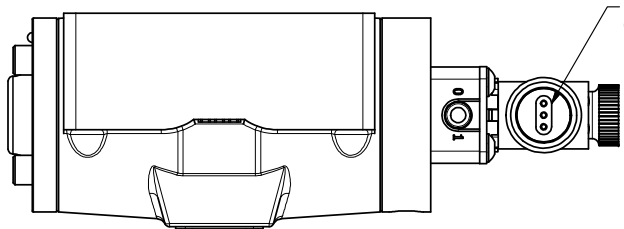

1/2"-14 NPT CONDUIT CONNECTION
18" LEAD, 3 WIRE

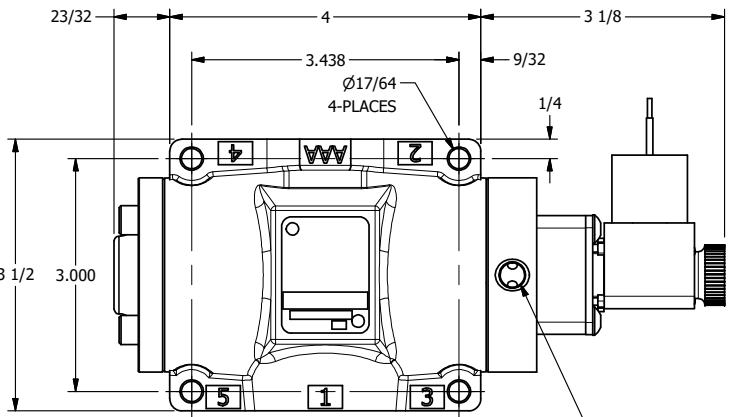

1/8" NPTF EXTERNAL PILOT PORT

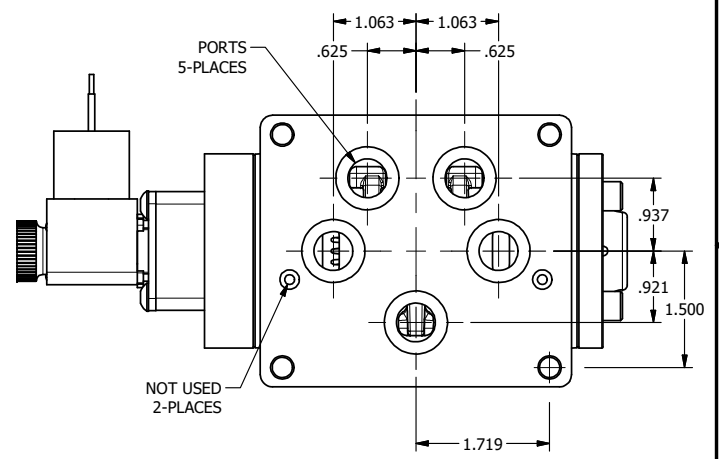
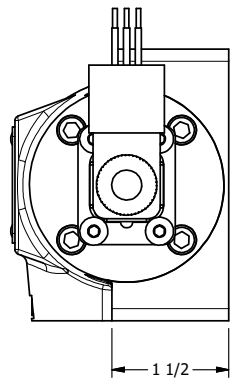
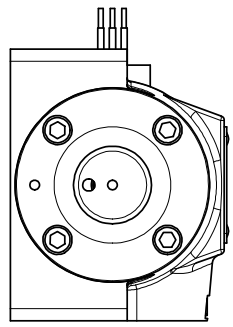

PORTS
5-PLACES

NOT USED
2-PLACES

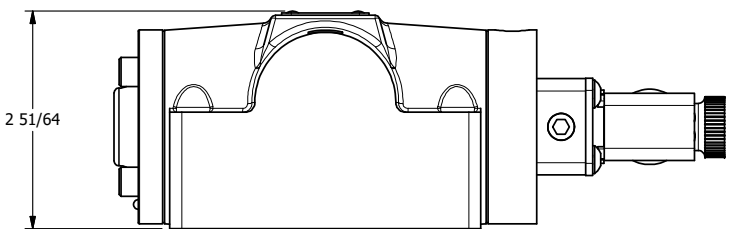

2 51/64

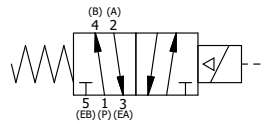

AAA
PRODUCTS
INTERNATIONAL

**AAA PRODUCTS
INTERNATIONAL**
7114 Harry Hines Blvd
Dallas, TX 75235

TITLE: 1/2" SUBPLATE, SNGL SOL, 2 POS,
SPR RTRN, MOLD-OVER,
DUST EXCLDR, EXT PILOT

DRAWING NO.:
DIM_ESO4PJLZ

THE INFORMATION CONTAINED WITHIN THIS DOCUMENT IS PROPRIETARY TO AAA PRODUCTS AND MAY NOT BE DISCLOSED WITHOUT PRIOR WRITTEN CONSENT

4

3

2

B

B

A

A