

4

3

2

1

1/8" NPTF EXTERNAL PILOT PORT
 11mm/INDUSTRIAL TYPE B DIN 43650 STYLE

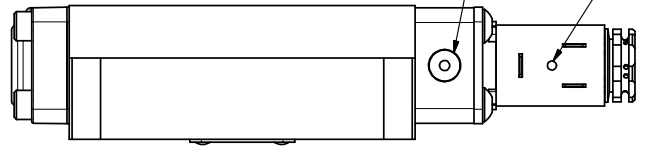

39/64 3 45/64 2 23/64
 3.344 3/16

Ø13/64
 4-PLACES

11/64

1 7/16

2 1/4

1.906

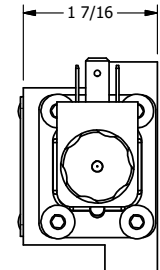
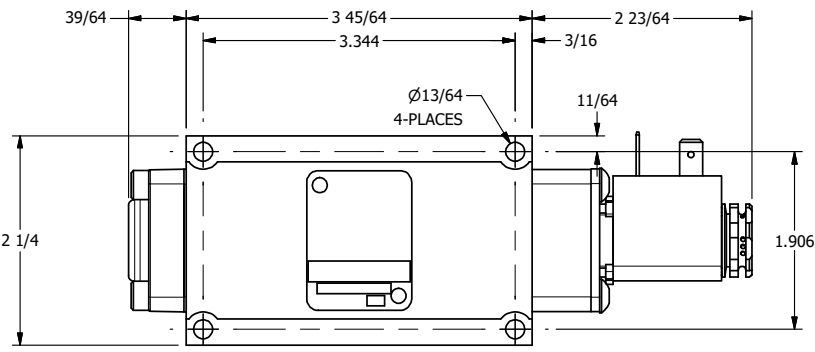
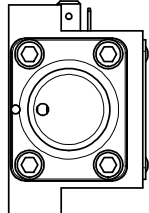

1.000 1.000
 .500 .500

PORTS
 5-PLACES

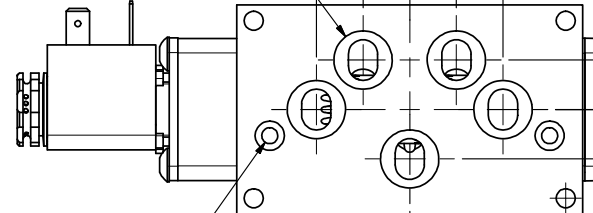

NOT USED
 2-PLACES

.531
 .953
 .531
 1.672

B

B

A

A

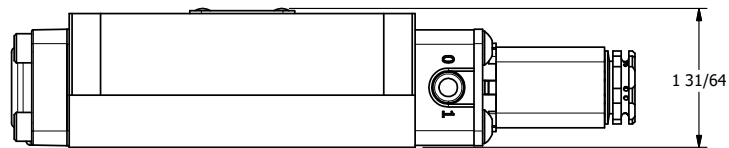

1 31/64

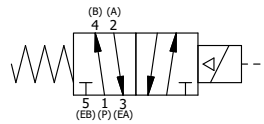

AAA
 PRODUCTS
 INTERNATIONAL

**AAA PRODUCTS
 INTERNATIONAL**
 7114 Harry Hines Blvd
 Dallas, TX 75235

TITLE **3/8" SUBPLATE, SNGL SOL, 2 POS,
 SPR RTRN,
 SIDE VENT, EXT PILOT**

DRAWING NO.:
DIM_ESO3PCZ

THE INFORMATION CONTAINED WITHIN THIS DOCUMENT IS PROPRIETARY TO AAA PRODUCTS AND MAY NOT BE DISCLOSED WITHOUT PRIOR WRITTEN CONSENT

4

3

2

