

4 3 2 1

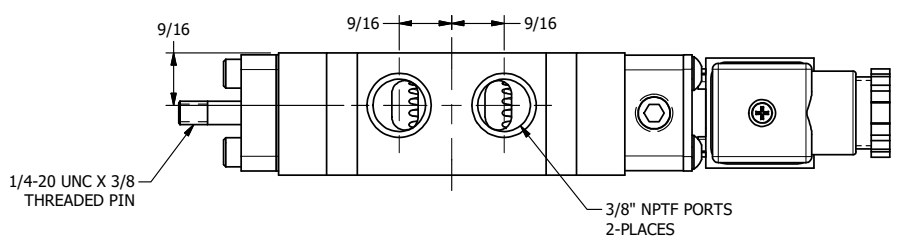

3/8" CORD GRIP DIN CAP INCLUDED
FORM A, ACC. TO EN 175301-803,
ISO 4400

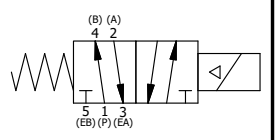
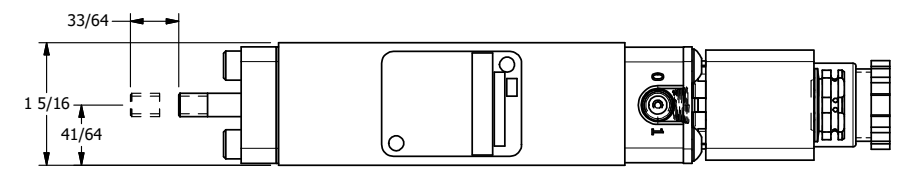
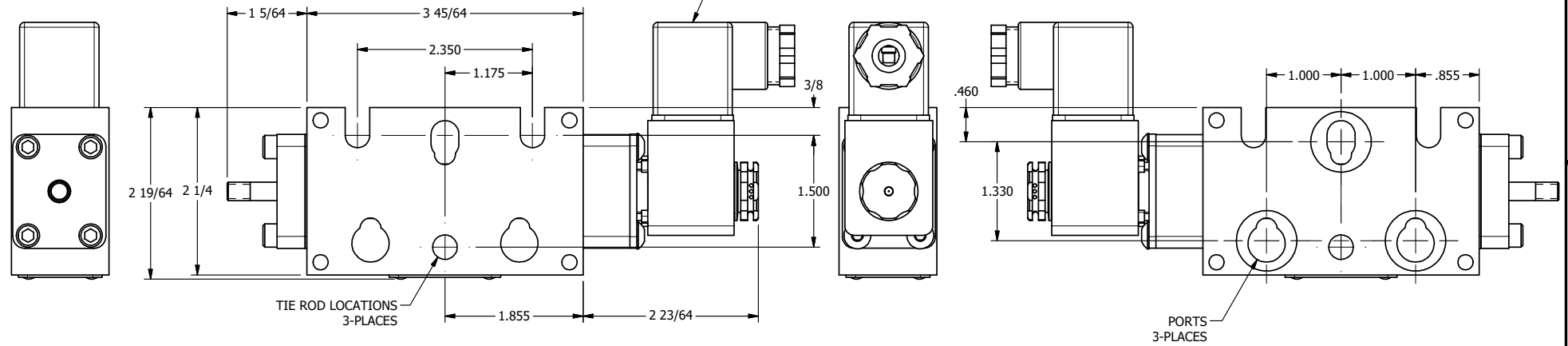

AAA
PRODUCTS
INTERNATIONAL

**AAA PRODUCTS
INTERNATIONAL**
7114 Harry Hines Blvd
Dallas, TX 75235

TITLE: 3/8" STACK, SNGL SOL, 2 POS,
SPR RTRN, INTR SAFE,
SIDE VENT, THD PIN

DRAWING NO.:
DIM_EBS03ACK

4 3 2 1

THE INFORMATION CONTAINED WITHIN THIS DOCUMENT IS PROPRIETARY TO AAA PRODUCTS AND MAY NOT BE DISCLOSED WITHOUT PRIOR WRITTEN CONSENT