

POSITION GASKET ON END OF VALVE TO SEAL PILOT HOLE SIDE 'B' ONLY

ALIGN PILOT AND SLOT IN ADAPTOR WITH GASKET IN BETWEEN SIDE 'A' ONLY FOR EXTERNAL PILOT OPERATION - ROTATE ADAPTOR 180 DEGREES. REMOVE 1/8" NPTF PLUG AND SUPPLY 50-150 PSI TO 1/8" NPTF PILOT PORT IN ADAPTOR.

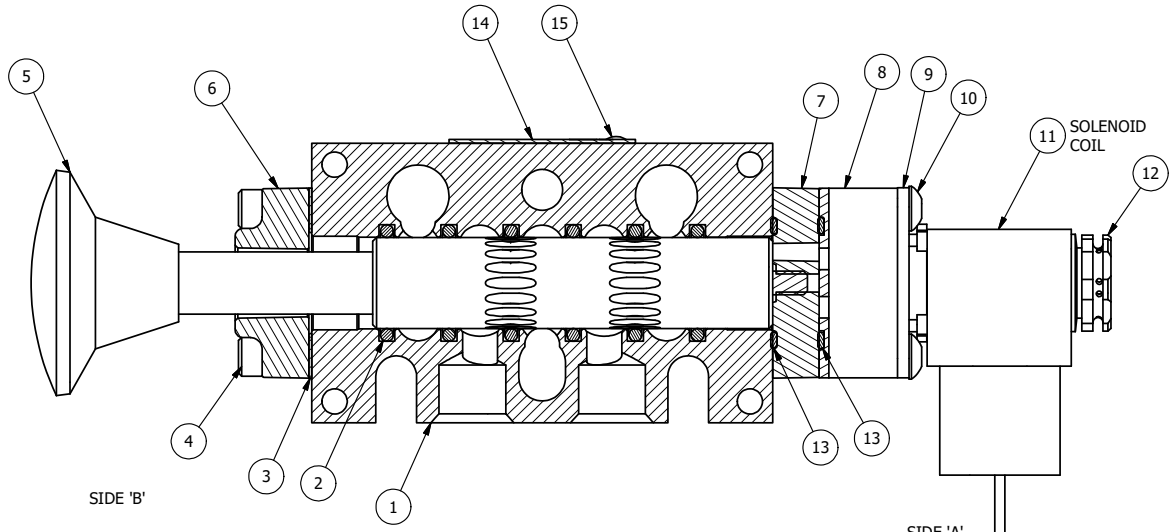

SECTION A-A
SCALE 1 : 1

NOTES:
1) ALWAYS GIVE VALVE MODEL AND PART NUMBER WHEN ORDERING PARTS.
2) FOR DIFFERENT VOLTAGES OTHER THAN 120/60, REPLACE SOLENOID COIL WITH COIL LISTED IN TABLE BELOW.

16	3	V-110	O-RING, BUNA-N, 70 DURO, AS-114, (REF 5/8 X 13/16 X 3/32), 1/4" SLEEVE, 1/2" SUB, STACK
15	2	V-212	SCREW, #2 X 3/16 DRIVE, TYPE U, OVAL HEAD, STAINLESS STEEL
14	1	AN-114	NAMEPLATE, BLANK, FOR VALVES WITH SPRINGS OR DETENTS
13	2	EMG3	GASKET - END MOUNT SOLENOID, BUNA-N, 1/4" & 3/8" VALVES
12	1	V-562	NUT, SOLENOID, SIDE EXHAUST
11	1	V-600-1	COIL - 1/2 NPTF HUB 120V 50/60HZ, NASS P/N 0561 44.1-00/4984
10	4	V-601	SCREW, 10-24 X 1-1/2, BUTTON HEAD SOCKET CAP WITH MICROSOPHERE ADHESIVE
9	1	SEC3-7	PLATE, RE-INFORCEMENT, SOLENOID, STAMPED, 304 STAINLESS
8	1	V-550-1	SOL OPER, END MOUNT, NON-LOCKING O/RIDE
7	1	AY-ESAK3	ASSY - NO DETENT, RTRN TO POS C, END MNT SOL W/PALM OVRD, 1/4" & 3/8" VALVES
6	1	PEC3-2	END CAP, PALM, 380 AL, 1/4" & 3/8" VALVE
5	1	V-71	KNOB, BLACK, PALM, (BRASS 5/16-18 INSERT), 1-13/16 DIA X 1-3/8 HEIGHT
4	4	V-38	SCREW, 10-24 X 3/4, SOCKET HEAD CAP
3	1	ECG3	GASKET - END CAP, 1/4" & 3/8" VALVE
2	6	V-39	O-RING, VITON, STD BODY, 1/4" & 3/8" VALVES
1	1	B3-10E	FINISHED - SOLID BODY, UPPER PILOTS, 3/8" STACKING VALVE
FLG	QTY	PART NO	DESCRIPTION

LIMITS ON DIMENSIONS
UNLESS OTHERWISE SPECIFIED

2-PL DECIMAL ± .01
3-PL DECIMAL ± .005
FRACTIONAL ± 1/64
ANGULAR ± 1/2°



DRAWN: RMckenna DATE: 3/27/2021 CHECKED: KWaite DATE: 3/27/2021
SCALE: 1 : 1 SHEET: 1 OF 1 RELEASED: HWomack DATE: 3/27/2021

COIL VOLTAGES	
PART NO	REPLACE COIL
EBSAK3JC 12VDC	V-600-2
EBSAK3JC 24VDC	V-600-3
EBSAK3JC 240/60	V-600-4

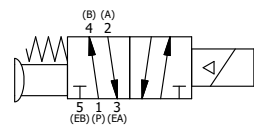

TITLE: 3/8" STACK, SNGL SOL, 2 POS, SPR RTRN, MOLD-OVER, 120/60, SIDE VENT, PALM ASSIST

PART NO.: EBSAK3JC

REV.:

THE INFORMATION CONTAINED WITHIN THIS DOCUMENT IS PROPRIETARY TO AAA PRODUCTS AND MAY NOT BE DISCLOSED WITHOUT PRIOR WRITTEN CONSENT