

NOTES:
1) ALWAYS GIVE VALVE MODEL AND PART NUMBER WHEN ORDERING PARTS.

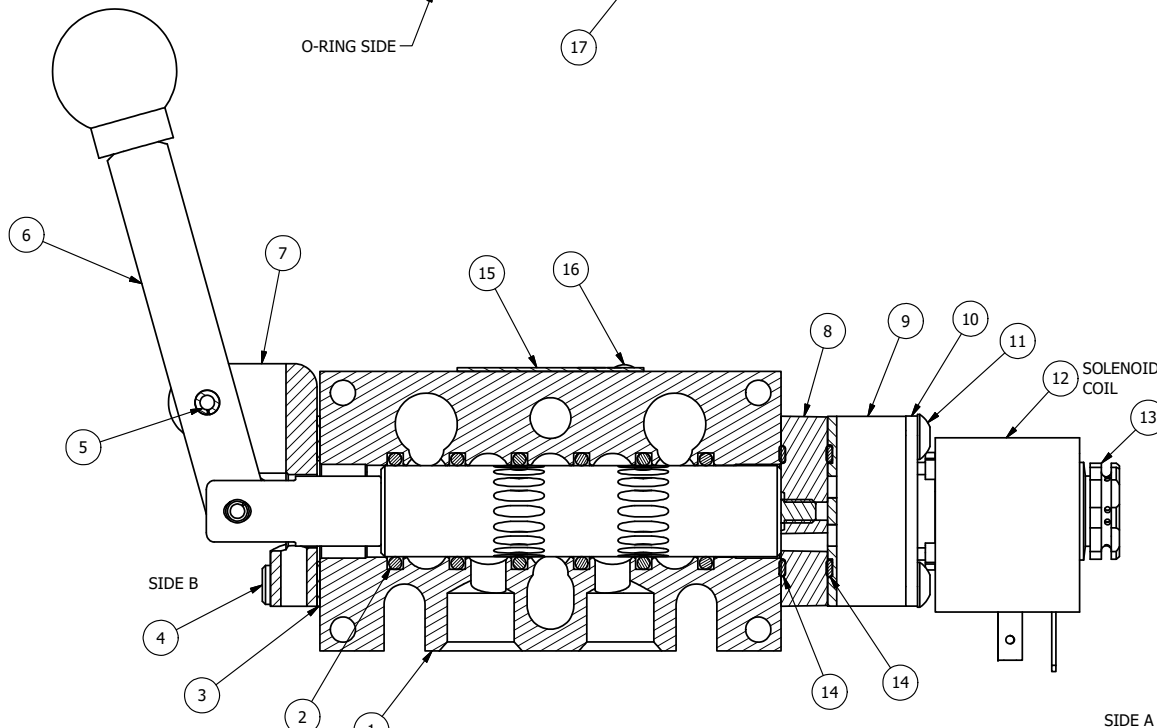

SECTION A-A
SCALE 1 : 1

17	3	V-110	O-RING, BUNA-N, 70 DURO, AS-114, (REF 5/8 X 13/16 X 3/32), 1/4" SLEEVE, 1/2" SUB, STACK
16	2	V-212	SCREW, #2 X 3/16 DRIVE, TYPE U, OVAL HEAD, STAINLESS STEEL
15	1	AN-114	NAMEPLATE, BLANK, FOR VALVES WITH SPRINGS OR DETENTS
14	2	EMG3	GASKET - END MOUNT SOLENOID, BUNA-N, 1/4" & 3/8" VALVES
13	1	V-562	NUT, SOLENOID, SIDE EXHAUST
12	1	V-603-1	COIL HI-TEMP. 8-30T 120/60. NASS # 0558 55.1-00/7121.
11	4	V-601	SCREW, 10-24 X 1-1/2, BUTTON HEAD SOCKET CAP WITH MICROSPHERE ADHESIVE
10	1	SEC3-7	PLATE, RE-INFORCEMENT, SOLENOID, STAMPED, 304 STAINLESS
9	1	V-550-1	SOL OPER, END MOUNT, NON-LOCKING O'RIDE
8	1	AY-ESA3	ASSY - NO DETENT, RTRN TO POS C, END MNT SOL W/HANDLE OVRD, 1/4" & 3/8" VALVES
7	1	HE3-4	ENDCAP - HAND OPERATOR, 303 STAINLESS, 1/4" & 3/8" STACK VALVE
6	1	HL3-24	HAND LEVER WITH KNOB, 1/4" & 3/8" VALVE
5	1	V-542	PIN, ROLL 3/16 X 1/2 ZINC PLATED STEEL FOR HE3-4 END CAP
4	4	V-162	SCREW, 10-24 X 5/8, SOCKET HEAD CAP
3	1	ECG3	GASKET - END CAP, 1/4" & 3/8" VALVE
2	6	V-39	O-RING, VITON, STD BODY, 1/4" & 3/8" VALVES
1	1	B3-10E	FINISHED - SOLID BODY, UPPER PILOTS, 3/8" STACKING VALVE
FLG	QTY	PART NO	DESCRIPTION

LIMITS ON DIMENSIONS UNLESS OTHERWISE SPECIFIED		2-PL DECIMAL ± .01 3-PL DECIMAL ± .005 FRACTIONAL ± 1/64 ANGULAR ± 1/2°		AAA PRODUCTS INTERNATIONAL 7114 Harry Hines Blvd Dallas, TX 75235
DRAWN: RMckenna	DATE: 4/12/2021	CHECKED: KWaite	DATE: 4/12/2021	
SCALE: 1 : 1	SHEET: 1 OF 1	RELEASED: HWomack	DATE: 4/12/2021	
TITLE: 3/8" STACK, SNGL SOL, 2 POS, SPR RTRN, H-TMP COIL, 120/60, LEVER ASSIST, SIDE VENT			PART NO.: EBSAH3HC	REV.:

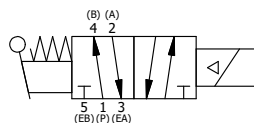

COIL VOLTAGES	
PART NO	REPLACE COIL
EBSAH3HC 12VDC	V-603-2

THE INFORMATION CONTAINED WITHIN THIS DOCUMENT IS PROPRIETARY TO AAA PRODUCTS AND MAY NOT BE DISCLOSED WITHOUT PRIOR WRITTEN CONSENT

P:\Engineering\product\valves\assembly\standards\AAADWG\EBSAH3HC.dwg