

POSITION GASKET ON END OF VALVE SO MOUNTING HOLES ALIGN, BOTH ENDS (SIDE 'A' SHOWN)

NOTES:
 1) ALWAYS GIVE VALVE MODEL AND PART NUMBER WHEN ORDERING PARTS.
 2) LUBRICATE DETENT BALL, SPRING AND STUD.

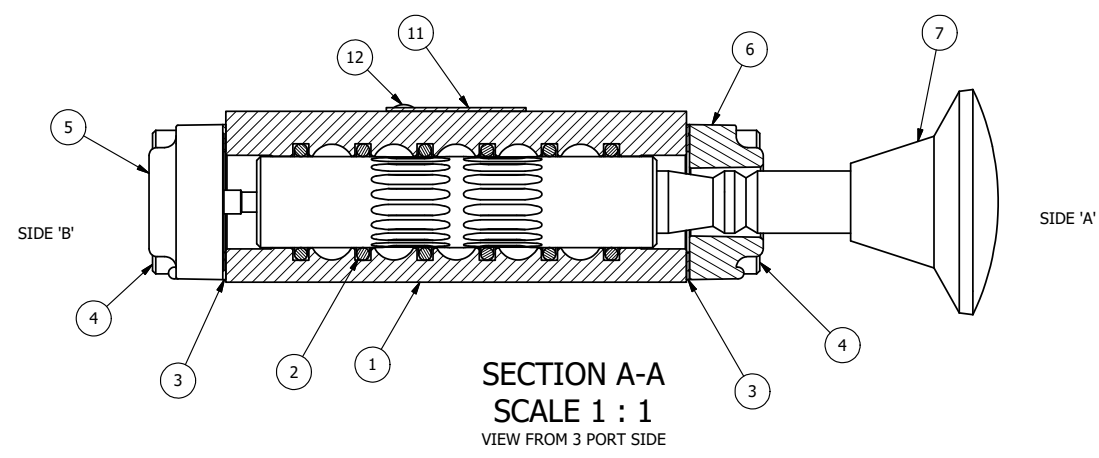

12	2	V-212	SCREW, #2 X 3/16 DRIVE, TYPE U, OVAL HEAD, STAINLESS STEEL
11	1	AN-114	NAMEPLATE, BLANK, FOR VALVES WITH SPRINGS OR DETENTS
10	2	V-14	BALL, CHROME STEEL 3/16 DIA, GRADE 25, FOR DETENT
9	2	DS3	SPRING - DETENT, 1/4" & 3/8" VALVE
8	2	V-21	SCREW, 1/4-20 X 3/16, SOCKET SET, CUP POINT
7	1	V-71	KNOB, BLACK, PALM, (BRASS 5/16-18 INSERT), 1-13/16 DIA X 1-3/8 HEIGHT
6	1	PEC3-3DD	END CAP, PALM, DOUBLE DETENT, 380 AL, 1/4" & 3/8" VALVE
5	1	AY-KX3D	ASSY - DETENT A, SPR CTR FROM C, REGEN CTR SPL, PALM, 1/4" & 3/8" VALVES
4	8	V-38	SCREW, 10-24 X 3/4, SOCKET HEAD CAP
3	2	ECG3	GASKET - END CAP, 1/4" & 3/8" VALVE
2	6	V-39	O-RING, VITON, STD BODY, 1/4" & 3/8" VALVES
1	1	B3-2E	BODY - SOLID, PLAIN, NO PILOTS, ANODIZED, 3/8" SIDE PORT VALVE
FLG	QTY	PART NO	DESCRIPTION

LIMITS ON DIMENSIONS UNLESS OTHERWISE SPECIFIED		2-PL DECIMAL ± .01 3-PL DECIMAL ± .005 FRACTIONAL ± 1/64 ANGULAR ± 1/2°		AAA PRODUCTS INTERNATIONAL 7114 Harry Hines Blvd Dallas, TX 75235
DRAWN: RMckenna	DATE: 9/19/2016	CHECKED: KWaite	DATE: 9/19/2016	
SCALE: 1:1	SHEET: 1 OF 1	RELEASED: HWomack	DATE: 9/19/2016	
TITLE: 3/8" SIDE PORT, PALM, 3 POS, DETENT A, SPR CTR FROM C, REGEN CTR SPL			PART NO.: KX3D	REV.:

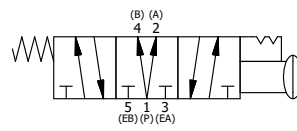

THE INFORMATION CONTAINED WITHIN THIS DOCUMENT IS PROPRIETARY TO AAA PRODUCTS AND MAY NOT BE DISCLOSED WITHOUT PRIOR WRITTEN CONSENT

P:\Engineering\product\Valve Assembly\Part\KX3D.dwg