

POSITION GASKET ON END OF VALVE SO MOUNTING HOLES ALIGN, BOTH ENDS (SIDE 'A' SHOWN)

NOTES:  
 1) ALWAYS GIVE VALVE MODEL AND PART NUMBER WHEN ORDERING PARTS.  
 2) LUBRICATE DETENT BALL, SPRING AND STUD.

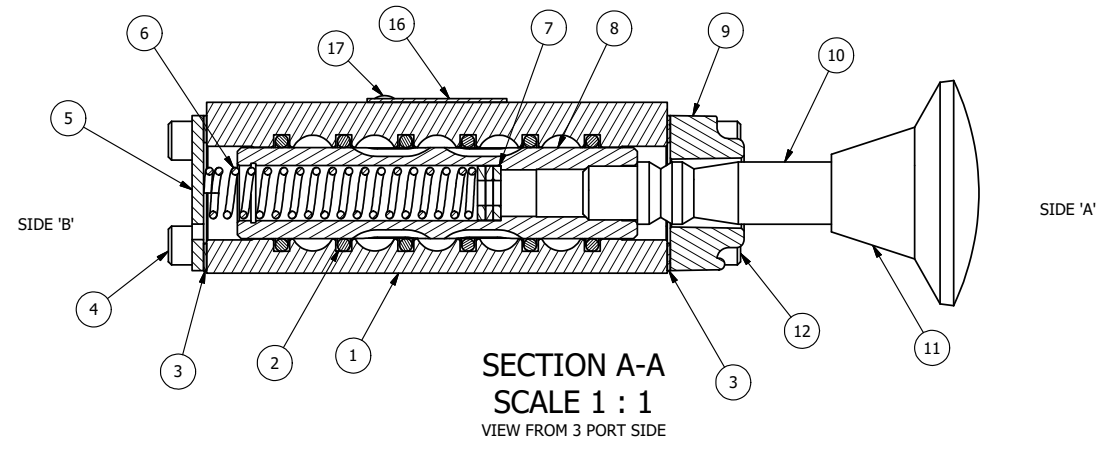

17	2	V-212	SCREW, #2 X 3/16 DRIVE, TYPE U, OVAL HEAD, STAINLESS STEEL
16	1	AN-114	NAMEPLATE, BLANK, FOR VALVES WITH SPRINGS OR DETENTS
15	2	V-14	BALL, CHROME STEEL 3/16 DIA, GRADE 25, FOR DETENT
14	2	DS3	SPRING - DETENT, 1/4" & 3/8" VALVE
13	2	V-21	SCREW, 1/4-20 X 3/16, SOCKET SET, CUP POINT
12	4	V-38	SCREW, 10-24 X 3/4, SOCKET HEAD CAP
11	1	V-71	KNOB, BLACK, PALM, (BRASS 5/16-18 INSERT), 1-13/16 DIA X 1-3/8 HEIGHT
10	1	PBS3-189	STUD - PALM, 189 ACTION, 1/4" & 3/8" VALVES
9	1	PEC3-3DD	END CAP, PALM, DOUBLE DETENT, 380 AL, 1/4" & 3/8" VALVE
8	1	SSH3D	SPOOL - 'D', 3 POS, REGEN CTR, 1/4" & 3/8" VALVE
7	3	V-43	WASHER - SPRING CTR, 302/304 STAINLESS STEEL, 1/4" & 3/8" VALVES
6	1	CS3-1	SPRING - CENTERING, 1/4" & 3/8" VALVES
5	1	SEC3	END CAP, 304 STAINLESS STEEL, 1/4" & 3/8" VALVE
4	4	V-37	SCREW, 10-24 X 1/2, SOCKET HEAD CAP
3	2	ECG3	GASKET - END CAP, 1/4" & 3/8" VALVE
2	6	V-39	O-RING, VITON, STD BODY, 1/4" & 3/8" VALVES
1	1	B3-2E	BODY - SOLID, PLAIN, NO PILOTS, ANODIZED, 3/8" SIDE PORT VALVE
FLG	QTY	PART NO	DESCRIPTION

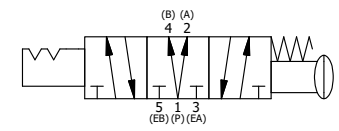

LIMITS ON DIMENSIONS UNLESS OTHERWISE SPECIFIED		2-PL DECIMAL ± .01 3-PL DECIMAL ± .005 FRACTIONAL ± 1/64 ANGULAR ± 1/2°		<b>AAA PRODUCTS INTERNATIONAL</b> 7114 Harry Hines Blvd Dallas, TX 75235
DRAWN: RMckenna	DATE: 9/14/2016	CHECKED: KWaite	DATE: 9/14/2016	
SCALE: 1:1	SHEET: 1 OF 1	RELEASED: HWomack	DATE: 9/14/2016	
TITLE: 3/8" SIDE PORT, PALM, 3 POS, DETENT C, SPR CTR FROM A, REGEN CTR SPL			PART NO.: KW3D	REV.:

THE INFORMATION CONTAINED WITHIN THIS DOCUMENT IS PROPRIETARY TO AAA PRODUCTS AND MAY NOT BE DISCLOSED WITHOUT PRIOR WRITTEN CONSENT

P:\Engineering\product\Valve Assembly\Palm KW3D.dwg