

POSITION GASKET ON END OF VALVE TO SEAL PILOT HOLE IF PRESENT, BOTH SIDES (SIDE 'B' SHOWN)

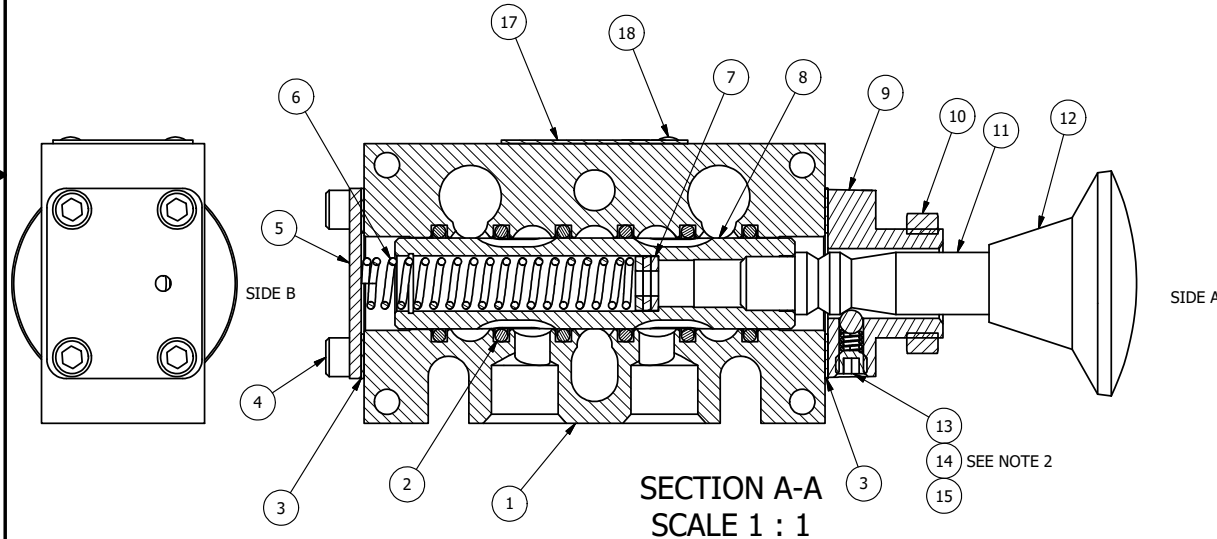

SECTION A-A
SCALE 1 : 1

- NOTES:
 1) ALWAYS GIVE VALVE MODEL AND PART NUMBER WHEN ORDERING PARTS.
 2) LUBRICATE DETENT BALL, SPRING AND STUD.

19	3	V-110	O-RING, BUNA-N, 70 DURO, AS-114, (REF 5/8 X 13/16 X 3/32), 1/4" SLEEVE, 1/2" SUB, STACK
18	2	V-212	SCREW, #2 X 3/16 DRIVE, TYPE U, OVAL HEAD, STAINLESS STEEL
17	1	AN-114	NAMEPLATE, BLANK, FOR VALVES WITH SPRINGS OR DETENTS
16	4	V-162	SCREW, 10-24 X 5/8, SOCKET HEAD CAP
15	1	V-14	BALL, CHROME STEEL 3/16 DIA, GRADE 25, FOR DETENT
14	1	DS3	SPRING - DETENT, 1/4" & 3/8" VALVE
13	1	V-21	SCREW, 1/4-20 X 3/16, SOCKET SET, CUP POINT
12	1	V-543	KNOB, RED (BRASS 5/16-18 INSERT), PALM, 1 13/16 DIA, PUSH/PULL, 1/4" & 3/8" VALVES
11	1	PBS3-189	STUD - PALM, 189 ACTION, 1/4" & 3/8" VALVES
10	1	V-501	NUT - PANEL MOUNT, YELLOW BRASS, 1/4" & 3/8" VALVE
9	1	PEC3-12	END CAP, PALM, PANEL MNT, DETENT, 303 STAINLESS STEEL, 1/4" & 3/8" VALVE
8	1	SSH3G	SPOOL - 'G', 3 POS, FLOAT CTR, 1/4" & 3/8" VALVE
7	3	V-43	WASHER - SPRING CTR, 302/304 STAINLESS STEEL, 1/4" & 3/8" VALVES
6	1	CS3-1	SPRING - CENTERING, 1/4" & 3/8" VALVES
5	1	SEC3	END CAP, 304 STAINLESS STEEL, 1/4" & 3/8" VALVE
4	4	V-37	SCREW, 10-24 X 1/2, SOCKET HEAD CAP
3	2	ECG3	GASKET - END CAP, 1/4" & 3/8" VALVE
2	6	V-39	O-RING, VITON, STD BODY, 1/4" & 3/8" VALVES
1	1	B3-10E	FINISHED - SOLID BODY, UPPER PILOTS, 3/8" STACKING VALVE
FLG	QTY	PART NO	DESCRIPTION

LIMITS ON DIMENSIONS
 UNLESS
 OTHERWISE SPECIFIED

2-PL DECIMAL ± .01
 3-PL DECIMAL ± .005
 FRACTIONAL ± 1/64
 ANGULAR ± 1/2°



DRAWN: RMckenna DATE: 5/2/2022

CHECKED: KWaite DATE: 5/2/2022

SCALE: 1 : 1 SHEET: 1 OF 1

RELEASED: HWomack DATE: 5/2/2022

TITLE:
 3/8" STACK, PALM, 3 POS,
 DETENT C, SPR CTR FROM A,
 FLOAT CTR SPL, RED KNOB, PANEL MNT

PART NO.:
 BKW3GJR

REV.:

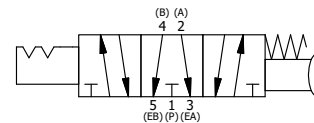

THE INFORMATION CONTAINED WITHIN THIS DOCUMENT IS PROPRIETARY TO AAA PRODUCTS AND MAY NOT BE DISCLOSED WITHOUT PRIOR WRITTEN CONSENT