

4 | 3 | 2 | 1

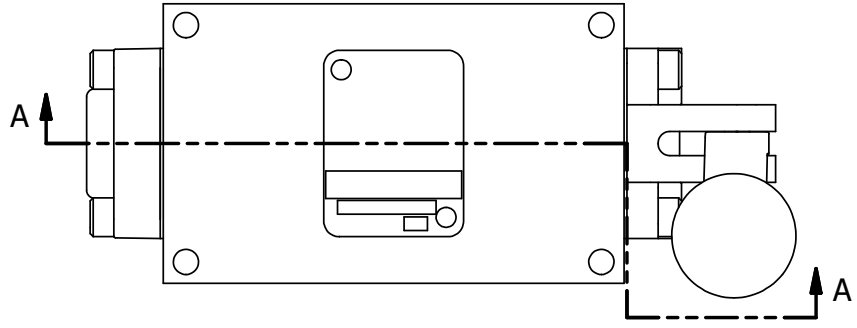

POSITION GASKET ON END OF VALVE SO MOUNTING HOLES ALIGN BOTH ENDS (SIDE 'B' SHOWN)

NOTES:
1) ALWAYS GIVE VALVE MODEL, AND PART NUMBER WHEN ORDERING PARTS.

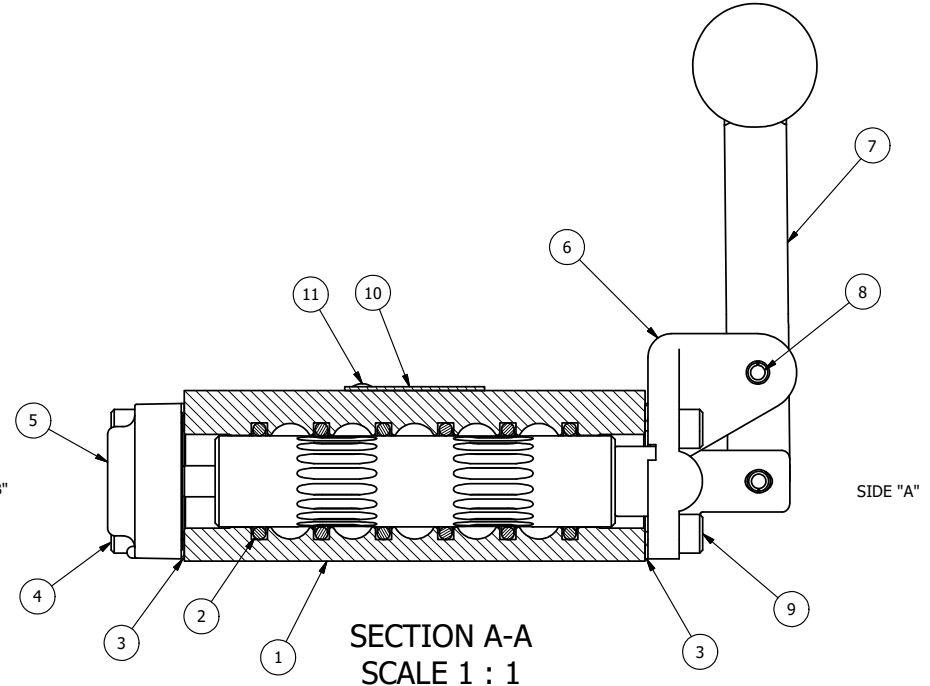

SECTION A-A
SCALE 1 : 1
VIEW FROM 3 PORT SIDE

FLG	QTY	PART NO	DESCRIPTION
11	2	V-212	SCREW, #2 X 3/16 DRIVE, TYPE U, OVAL HEAD, STAINLESS STEEL
10	1	AN-114	NAMEPLATE, BLANK, FOR VALVES WITH SPRINGS OR DETENTS
9	4	V-162	SCREW, 10-24 X 5/8, SOCKET HEAD CAP
8	1	V-508	PIN, ROLL 3/16 X 5/8 ZINC PLATED STEEL FOR 1/4 FOOT ENDCAP
7	1	HL3-521B20	HAND LEVER WITH RED KNOB, BENT 20 DEG SIDEWAYS, 1/4" & 3/8" VALVES
6	1	HE3-5	END CAP, LEVER, 303 STAINLESS, 1/4" & 3/8" VALVE
5	1	AY-HY3G	ASSY - SPR CTR, FLOAT CTR SPL, LEVER OR TREADLE, 1/4" & 3/8" VALVES
4	4	V-38	SCREW, 10-24 X 3/4, SOCKET HEAD CAP
3	2	ECG3	GASKET - END CAP, 1/4" & 3/8" VALVE
2	6	V-39	O-RING, VITON, STD BODY, 1/4" & 3/8" VALVES
1	1	B3-2E	BODY - SOLID, PLAIN, NO PILOTS, ANODIZED, 3/8" SIDE PORT VALVE

LIMITS ON DIMENSIONS UNLESS OTHERWISE SPECIFIED		2-PL DECIMAL ± .01 3-PL DECIMAL ± .005 FRACTIONAL ± 1/64 ANGULAR ± 1/2°		AAA PRODUCTS INTERNATIONAL 7114 Harry Hines Blvd Dallas, TX 75235
DRAWN: RMckenna	DATE: 1/29/2025	CHECKED: KWaite	DATE: 1/29/2025	
SCALE: 1 : 1	SHEET: 1 OF 1	RELEASED: HWomack	DATE: 1/29/2025	
TITLE: 3/8" SIDE PORT, LEVER, 3 POS, SPR FLOAT CTR, BNT LVR LFT, HVY DTY, RED KNOB			PART NO.: HY3GBLHJ	REV.:

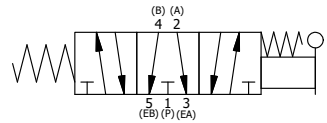

4 | 3 | 2 | 1

THE INFORMATION CONTAINED WITHIN THIS DOCUMENT IS PROPRIETARY TO AAA PRODUCTS AND MAY NOT BE DISCLOSED WITHOUT PRIOR WRITTEN CONSENT

D:\Engineering\Products\Valves\Assembly\HY3GBLHJ.dwg