

POSITION GASKET ON END OF VALVE SO
MOUNTING HOLES ALIGN
BOTH ENDS (SIDE 'A' SHOWN)

NOTES:
1) ALWAYS GIVE VALVE MODEL, AND PART NUMBER WHEN ORDERING PARTS.
2) LUBRICATE DETENT BALL, SPRING AND CLEVIS.

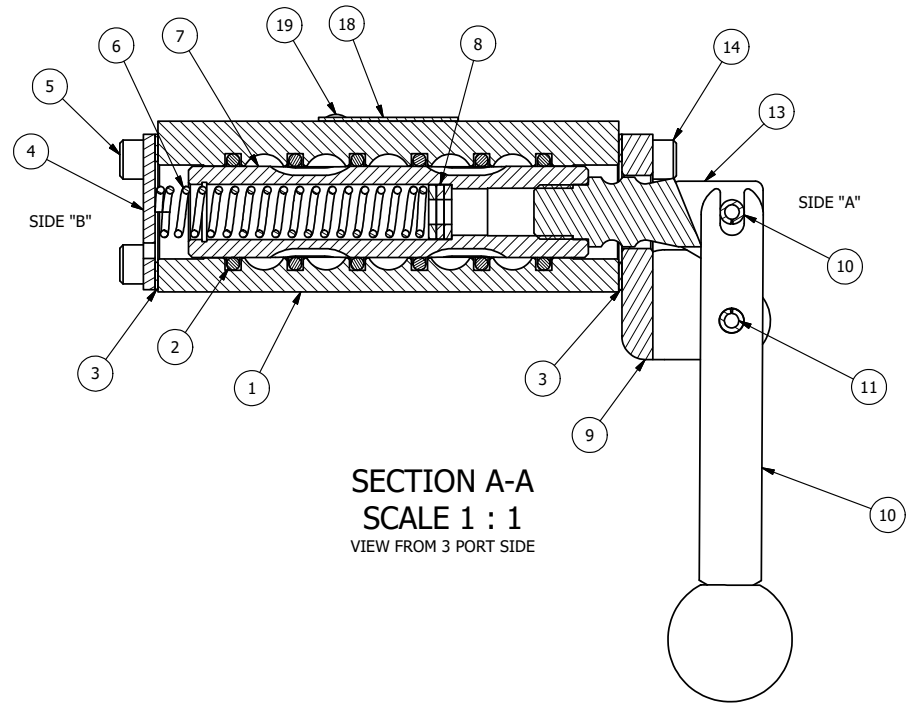

19	2	V-212	SCREW, #2 X 3/16 DRIVE, TYPE U, OVAL HEAD, STAINLESS STEEL
18	1	AN-114	NAMEPLATE, BLANK, FOR VALVES WITH SPRINGS OR DETENTS
17	2	V-14	BALL, CHROME STEEL 3/16 DIA, GRADE 25, FOR DETENT
16	2	DS3	SPRING - DETENT, 1/4" & 3/8" VALVE
15	2	V-21	SCREW, 1/4-20 X 3/16, SOCKET SET, CUP POINT
14	4	V-162	SCREW, 10-24 X 5/8, SOCKET HEAD CAP
13	1	HC3-189	CLEVIS - HAND, STAINLESS, 189VY ACTION, 1/4" & 3/8" VALVE
12	1	V-48	PIN, ROLL 3/16 X 9/16, STEEL, ZINC PLATED
11	1	V-508	PIN, ROLL 3/16 X 5/8 ZINC PLATED STEEL FOR 1/4 FOOT ENDCAP
10	1	HL3-521	HAND LEVER WITH RED KNOB, 1/4" & 3/8" VALVE
9	1	HE3-5DD	END CAP, LEVER, DOUBLE DETENT, 303 STAINLESS STEEL, 1/4" & 3/8" VALVE
8	3	V-43	WASHER - SPRING CTR, 302/304 STAINLESS STEEL, 1/4" & 3/8" VALVES
7	1	SSH3G	SPOOL - 'G', 3 POS, FLOAT CTR, 1/4" & 3/8" VALVE
6	1	CS3-1	SPRING - CENTERING, 1/4" & 3/8" VALVES
5	4	V-37	SCREW, 10-24 X 1/2, SOCKET HEAD CAP
4	1	SEC3	END CAP, 304 STAINLESS STEEL, 1/4" & 3/8" VALVE
3	2	ECG3	GASKET - END CAP, 1/4" & 3/8" VALVE
2	6	V-39	O-RING, VITON, STD BODY, 1/4" & 3/8" VALVES
1	1	B3-2E	BODY - SOLID, PLAIN, NO PILOTS, ANODIZED, 3/8" SIDE PORT VALVE
FLG	QTY	PART NO	DESCRIPTION

LIMITS ON DIMENSIONS UNLESS OTHERWISE SPECIFIED		2-PL DECIMAL ± .01 3-PL DECIMAL ± .005 FRACTIONAL ± 1/64 ANGULAR ± 1/2°		AAA PRODUCTS INTERNATIONAL 7114 Harry Hines Blvd Dallas, TX 75235
DRAWN: RMckenna	DATE: 2/3/2025	CHECKED: KWaite	DATE: 2/3/2025	
SCALE: 1 : 1	SHEET: 1 OF 1	RELEASED: HWomack	DATE: 2/3/2025	
TITLE: 3/8" SIDE PORT, LEVER, 3 POS, SPR REGEN CTR FRM A, DTNT C, CHVY DTY, RED KNOB, 180D LVR			PART NO.: HW3GHJT	REV.:

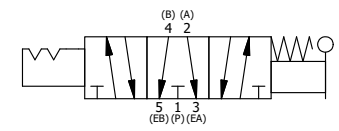

THE INFORMATION CONTAINED WITHIN THIS DOCUMENT IS PROPRIETARY TO AAA PRODUCTS AND MAY NOT BE DISCLOSED WITHOUT PRIOR WRITTEN CONSENT