

POSITION GASKET ON END OF VALVE SO MOUNTING HOLES ALIGN BOTH ENDS (SIDE 'A' SHOWN)

NOTES:

1) ALWAYS GIVE VALVE MODEL, AND PART NUMBER WHEN ORDERING PARTS.

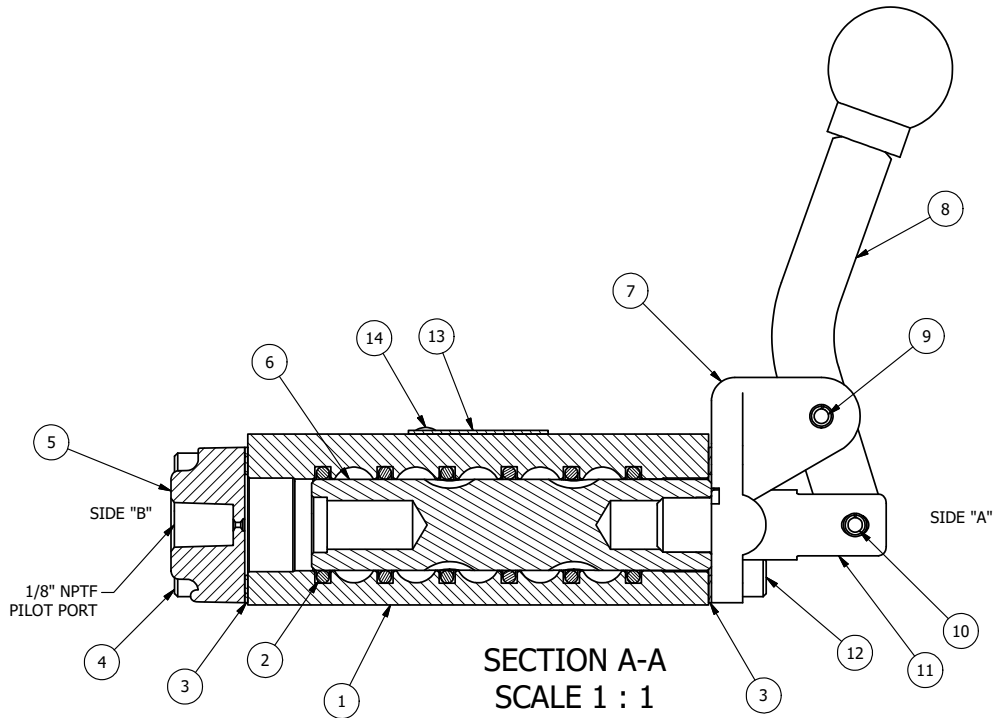

SECTION A-A
SCALE 1 : 1
VIEW FROM 3 PORT SIDE

FLG	QTY	PART NO	DESCRIPTION
14	2	V-212	SCREW, #2 X 3/16 DRIVE, TYPE U, OVAL HEAD, STAINLESS STEEL
13	1	AN-115	NAMEPLATE, BLANK, FOR HE,KE,RR,D,CR,PP,SR,SS VALVES
12	4	V-162	SCREW, 10-24 X 5/8, SOCKET HEAD CAP
11	1	HC3	CLEVIS - NO DETENTS, 1/4" & 3/8" VALVE
10	1	V-48	PIN, ROLL 3/16 X 9/16, STEEL, ZINC PLATED
9	1	V-508	PIN, ROLL 3/16 X 5/8 ZINC PLATED STEEL FOR 1/4 FOOT ENDCAP
8	1	HL3-24C	CURVED HAND LEVER WITH KNOB, 1/4" & 3/8" VALVE
7	1	HE3-5	END CAP, LEVER, 303 STAINLESS, 1/4" & 3/8" VALVE
6	1	S3R	SPOOL - SOLID, STANDARD, 2 POS, CLSD CTR, 1/4" & 3/8" VALVE
5	1	PEC3	END CAP, PILOT, 300 AL, 1/4" & 3/8" VALVE
4	4	V-38	SCREW, 10-24 X 3/4, SOCKET HEAD CAP
3	2	ECG3	GASKET - END CAP, 1/4" & 3/8" VALVE
2	6	V-39	O-RING, VITON, STD BODY, 1/4" & 3/8" VALVES
1	1	B3-2E	BODY - SOLID, PLAIN, NO PILOTS, ANODIZED, 3/8" SIDE PORT VALVE
FLG	QTY	PART NO	DESCRIPTION

LIMITS ON DIMENSIONS UNLESS OTHERWISE SPECIFIED		2-PL DECIMAL ± .01 3-PL DECIMAL ± .005 FRACTIONAL ± 1/64 ANGULAR ± 1/2°		AAA PRODUCTS INTERNATIONAL 7114 Harry Hines Blvd Dallas, TX 75235
DRAWN: RMckenna	DATE: 3/23/2023	CHECKED: KWaite	DATE: 3/23/2023	
SCALE: 1 : 1	SHEET: 1 OF 1	RELEASED: HWomack	DATE: 3/23/2023	
TITLE: 3/8" SIDE PORT, LEVER, 2 POS, PILOT RTRN, CRVD LVR, HVV DTY			PART NO.: HR3CH	REV.:

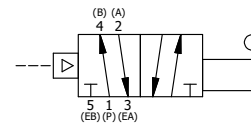

THE INFORMATION CONTAINED WITHIN THIS DOCUMENT IS PROPRIETARY TO AAA PRODUCTS AND MAY NOT BE DISCLOSED WITHOUT PRIOR WRITTEN CONSENT

D:\Engineering\product\valves\assembly\lever\HR3CH\HR3CH.dwg