

4

3

2

1

Ø.257 THRU HOLE
WHEN IN POSITION SHOWN

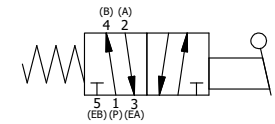
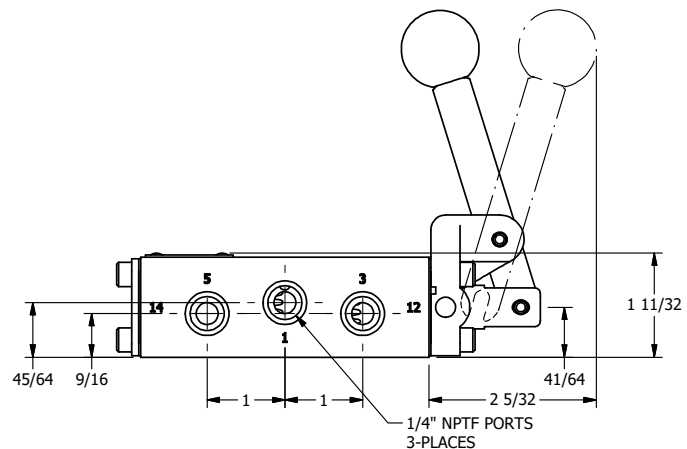
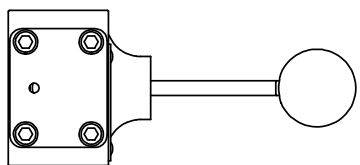
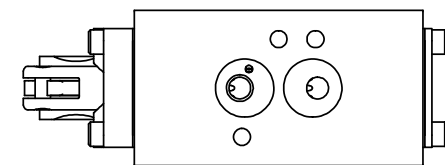
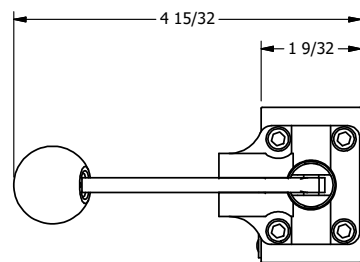
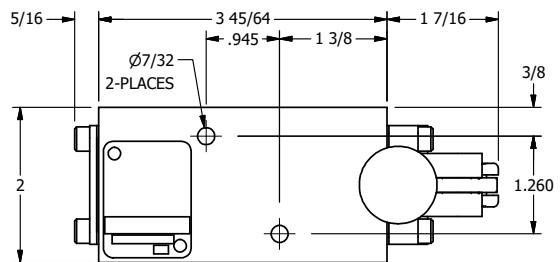
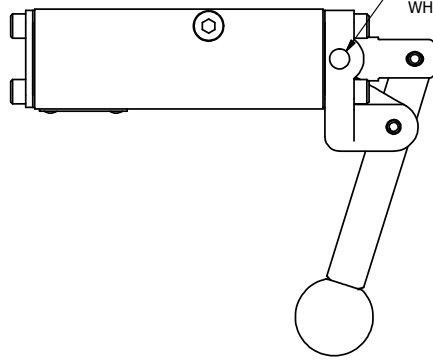

AAA
PRODUCTS
INTERNATIONAL
7114 Harry Hines Blvd
Dallas, TX 75235

TITLE: 1/4" NAMUR, LEVER, 2 POS,
SPRING RTRN, RED KNOB, LOCKOUT C

DRAWING NO.:
DIM_NHO2JLO

THE INFORMATION CONTAINED WITHIN THIS DOCUMENT IS PROPRIETARY TO AAA PRODUCTS AND MAY NOT BE DISCLOSED WITHOUT PRIOR WRITTEN CONSENT

4

3

2

1

B

B

A

A