

4

3

2

1

B

B

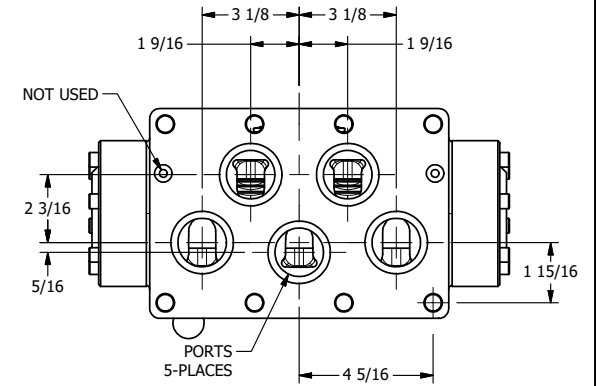
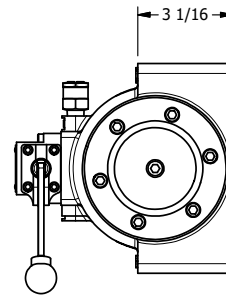
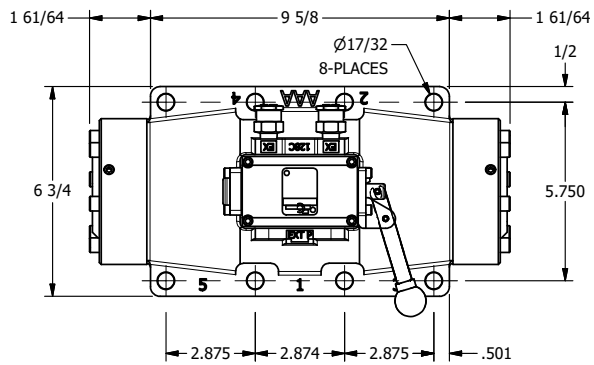
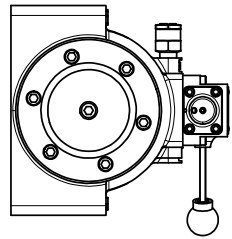
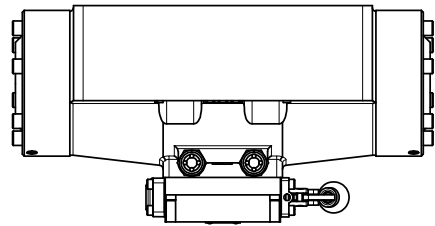

A

A

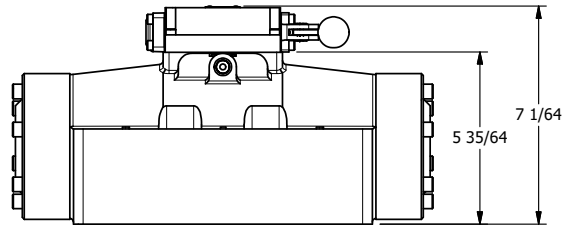

4

3

2

1

B

B



TITLE: 2" SUBPLATE, LEVER, 2 POS,  
RVRS SPR RTRN, 270D LEVER,  
EXTERNAL PILOT

DRAWING NO.: DIM\_HA16PRTZ

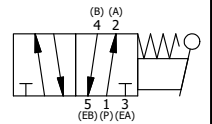

THE INFORMATION CONTAINED WITHIN THIS DOCUMENT IS PROPRIETARY TO AAA PRODUCTS AND MAY NOT BE DISCLOSED WITHOUT PRIOR WRITTEN CONSENT