

ALIGN HOLES IN GASKET AS SHOWN.
 (FOR EXTERNAL PILOT PRESSURE, REMOVE PIGGY BACK BLOCK AND ROTATE 180°. LEAVE GASKET AS SHOWN. REMOVE 1/8" PLUG AND CONNECT SUPPLY PRESSURE - 160 PSI MAX.)

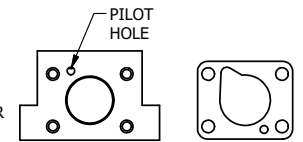

ALIGN PILOT HOLE AND CENTER CUTOUT ON BOTH SIDES.

NOTES:
 1) ALWAYS GIVE VALVE MODEL AND PART NUMBER WHEN ORDERING PARTS.
 2) FOR DIFFERENT VOLTAGES OTHER THAN 120/60, REPLACE SOLENOID OPERATOR WITH OPERATOR LISTED IN TABLE BELOW. REFERENCE AY-38EDL DRAWING FOR REPLACEMENT COILS.

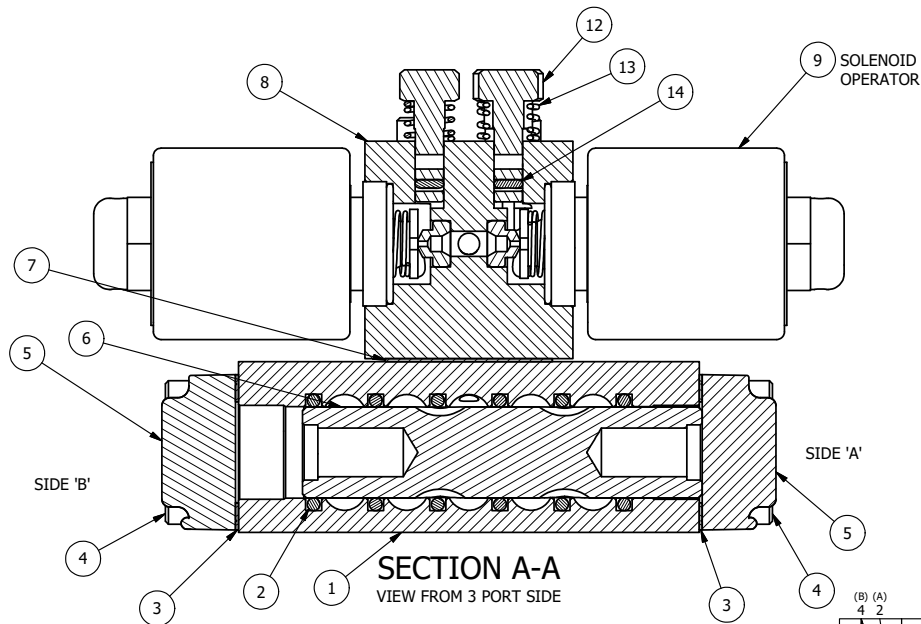

SECTION A-A
 VIEW FROM 3 PORT SIDE

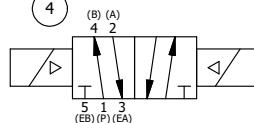

OPERATOR VOLTAGES	
PART NO	REPLACE OPERATOR
SS3EDOL 12VDC	AY-38EDL-5
SS3EDOL 24VDC	AY-38EDL-8
SS3EDOL 240/60	AY-38EDL-17

FLG	QTY	PART NO	DESCRIPTION
17	2	V-212	SCREW, #2 X 3/16 DRIVE, TYPE U, OVAL HEAD, STAINLESS STEEL
16	1	AN-115	NAMEPLATE, BLANK, FOR HE,KE,KD,RR,D,CR,PP,SR,SS VALVES
15	2	V-81	SCREW, 8-32 X 5/16, SOCKET SET, FULL DOG POINT
14	2	V-85	O-RING, BUNA-N, 70 DURO, AS-010, (REF 1/4 X 3/8 X 1/16), CLASSIC OVRD
13	2	OS3	SPRING - MANUAL OVERRIDE, "CLASSIC" SOLENOID
12	2	OP3	PIN - MANUAL OVERRIDE, 1/4" & 3/8" VALVES
11	1	V-19	PLUG, SOCKET PIPE 1/8" NPT (#601-3 PITTSBURG PLUG PART #.)
10	4	V-1	SCREW, 10-24 X 2, SOCKET HEAD CAP
9	2	AY-38EDL-11	CLASSIC SOLENOID - ISO 4400 DIN, DUST EXCLUDER NUT, 120/60
8	1	PB3-4E	ADAPTOR - DBL SOL., W/OVERRIDE, 1/4" & 3/8" VALVES
7	1	PBG3	GASKET - PIGGY BACK, DOUBLE SOLENOID, 1/4" & 3/8" VALVE
6	1	S3R	SPOOL - SOLID, STANDARD, 2 POS, CLSD CTR, 1/4" & 3/8" VALVE
5	2	SEC3-1	END CAP, NON-VENTED, 380 AL, 1/4" & 3/8" VALVES
4	8	V-38	SCREW, 10-24 X 3/4, SOCKET HEAD CAP
3	2	ECG3	GASKET - END CAP, 1/4" & 3/8" VALVE
2	6	V-39	O-RING, VITON, STD BODY, 1/4" & 3/8" VALVES
1	1	B3-6E	BODY - SOLID, PIGGY BACK, ANODIZED, 3/8" SIDE PORT VALVE

LIMITS ON DIMENSIONS
 UNLESS OTHERWISE SPECIFIED
 2-PL DECIMAL ± .01
 3-PL DECIMAL ± .005
 FRACTIONAL ± 1/64
 ANGULAR ± 1/2°



DRAWN: RMckenna	DATE: 4/5/2016	CHECKED: KWaite	DATE: 4/5/2016
SCALE: 1 : 1	SHEET: 1 OF 1	RELEASED: HWomack	DATE: 4/5/2016
TITLE: 3/8" SIDE PORT, DBL SOL, 2 POS, FRICTION POS, ISO 4400 DIN, 120/60, LCKNG OVRD, DUST EXCLDR		PART NO.:	REV.:
		SS3EDOL	

THE INFORMATION CONTAINED WITHIN THIS DOCUMENT IS PROPRIETARY TO AAA PRODUCTS AND MAY NOT BE DISCLOSED WITHOUT PRIOR WRITTEN CONSENT

D:\Engineering\Product\Valve Assembly\Classic\SS3EDOL.dwg