

4

3

2

1

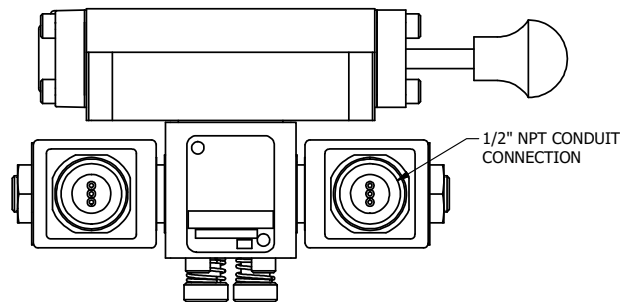

1/2" NPT CONDUIT CONNECTION

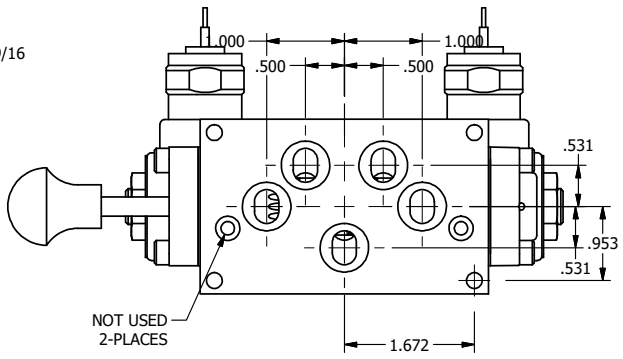
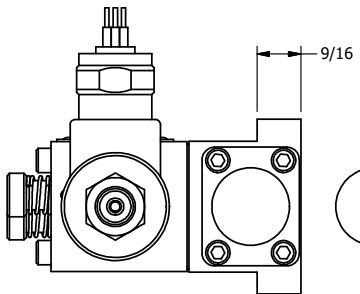
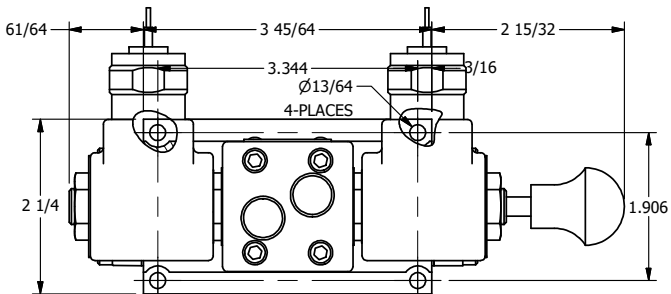
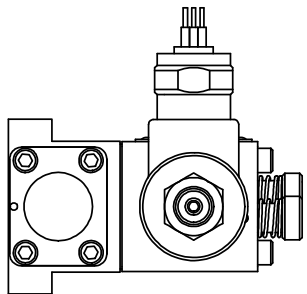

NOT USED 2-PLACES

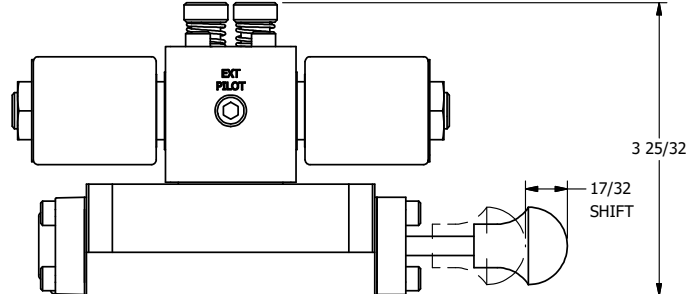

3 25/32

17/32 SHIFT

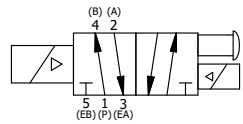

AAA
PRODUCTS
INTERNATIONAL

AAA PRODUCTS INTERNATIONAL
7114 Harry Hines Blvd
Dallas, TX 75235

TITLE: 3/8" SUBPLATE, DBL SOL, 2 POS,
FRCTN POS, SOL RTRN, MOLD-OVER,
PUSH OVRD, MAN SPL OVRD

DRAWING NO.:
DIM_SS3PMOPOS

THE INFORMATION CONTAINED WITHIN THIS DOCUMENT IS PROPRIETARY TO AAA PRODUCTS AND MAY NOT BE DISCLOSED WITHOUT PRIOR WRITTEN CONSENT

4

3

2

1

B

B

A

A