

4

3

2

1

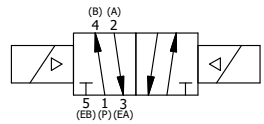
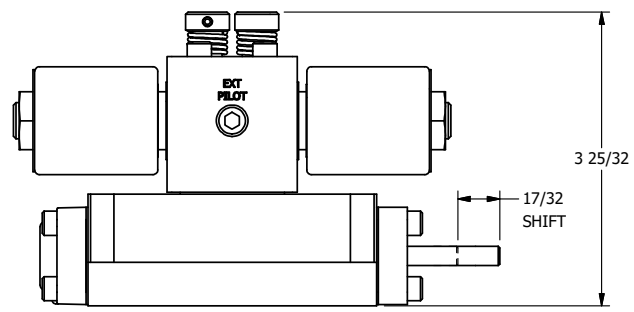
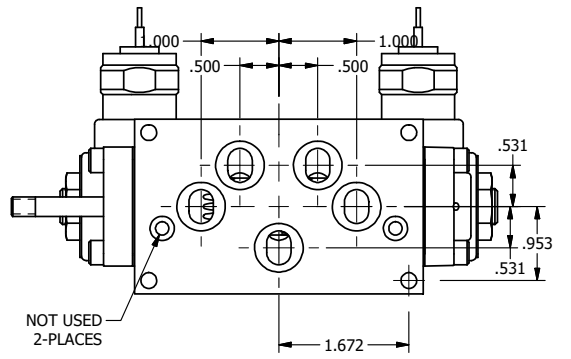
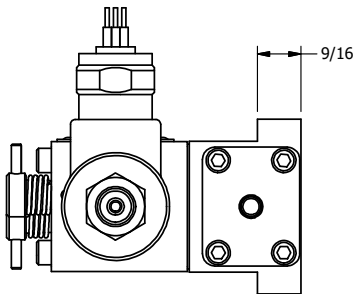
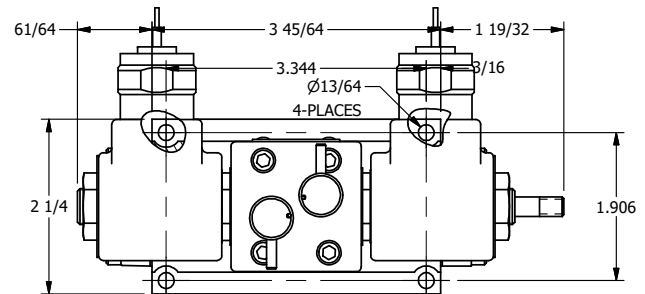
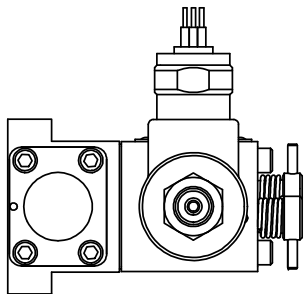
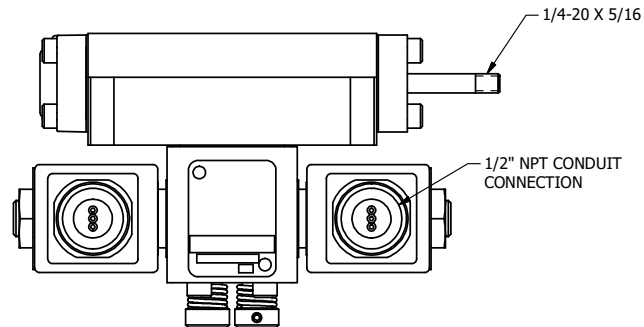

AAA
PRODUCTS
INTERNATIONAL

AAA PRODUCTS INTERNATIONAL
7114 Harry Hines Blvd
Dallas, TX 75235

TITLE: 3/8" SUBPLATE, DBL SOL, 2 POS,
SOL RTN, MOLD-OVER,
NON-LCKNG OVRD, THD PIN

DRAWING NO.:
DIM_SS3PMONK

THE INFORMATION CONTAINED WITHIN THIS DOCUMENT IS PROPRIETARY TO AAA PRODUCTS AND MAY NOT BE DISCLOSED WITHOUT PRIOR WRITTEN CONSENT

4

3

2

