

4

3

2

1

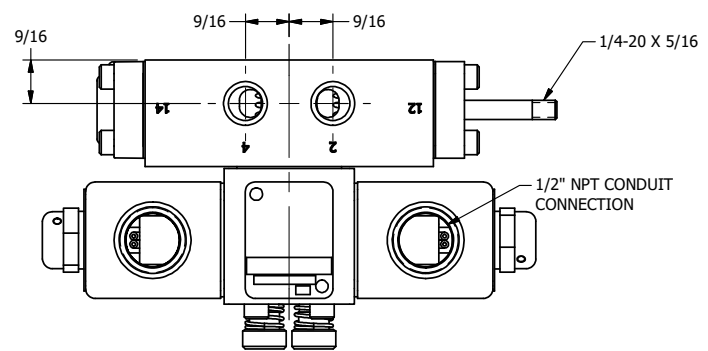

1/2" NPT CONDUIT CONNECTION

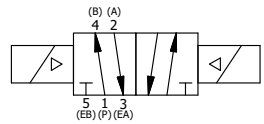
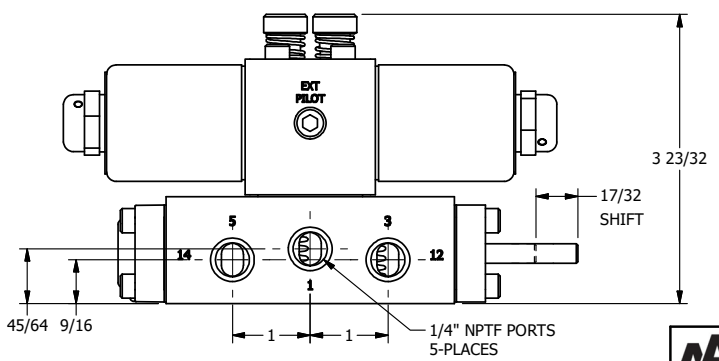
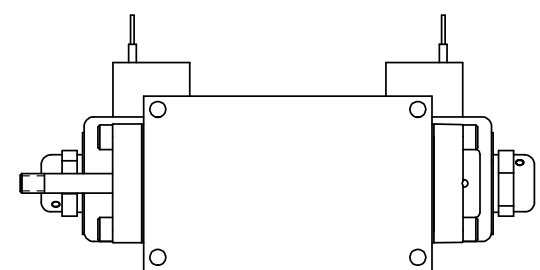
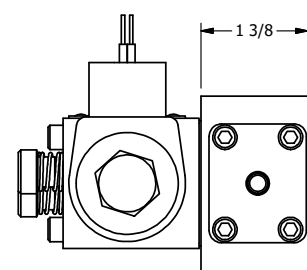
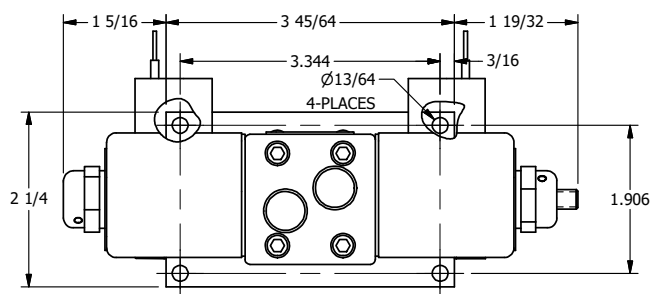
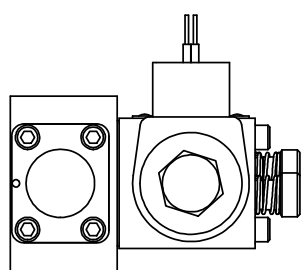

AAA
PRODUCTS
INTERNATIONAL

AAA PRODUCTS INTERNATIONAL
7114 Harry Hines Blvd
Dallas, TX 75235

TITLE: 1/4" SIDE PORT, DBL SOL, 2 POS,
FRCTN POS, SOL RTRN, CLASSIC SOL,
LCKNG OVRD, EXCLDR, THD PIN

DRAWING NO.:
DIM_SS20LK

4

3

2

THE INFORMATION CONTAINED WITHIN THIS DOCUMENT IS PROPRIETARY TO AAA PRODUCTS AND MAY NOT BE DISCLOSED WITHOUT PRIOR WRITTEN CONSENT