

2

1

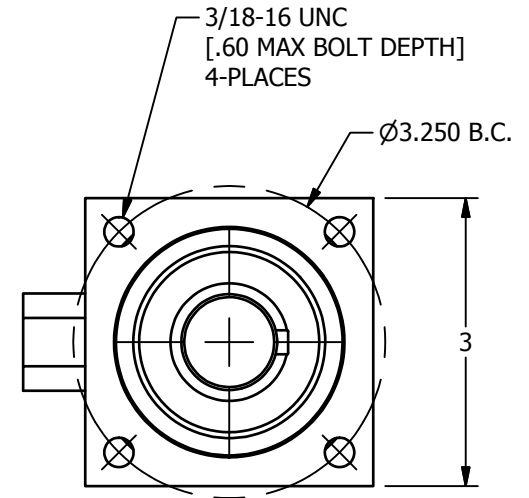

PRESSURIZING PORT B WILL ROTATE THE
SHAFT COUNTER-CLOCKWISE.
(PRESSURIZE PORT A FOR CLOCKWISE)

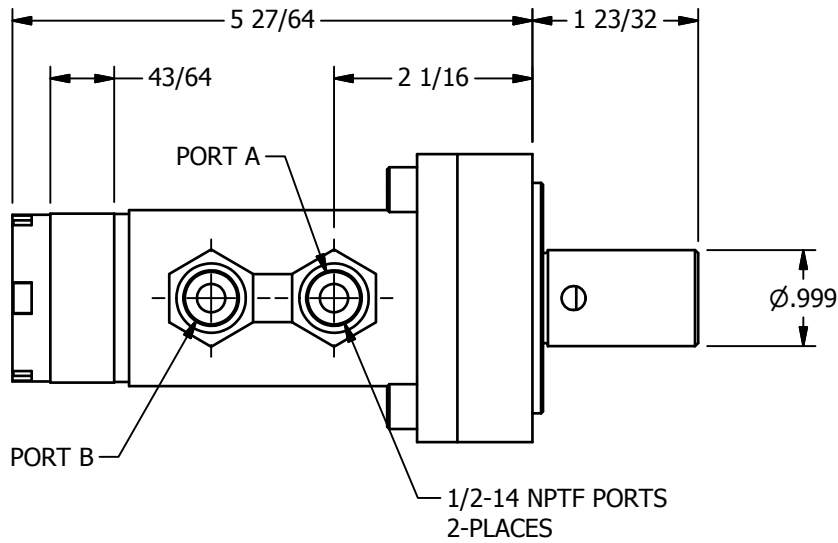
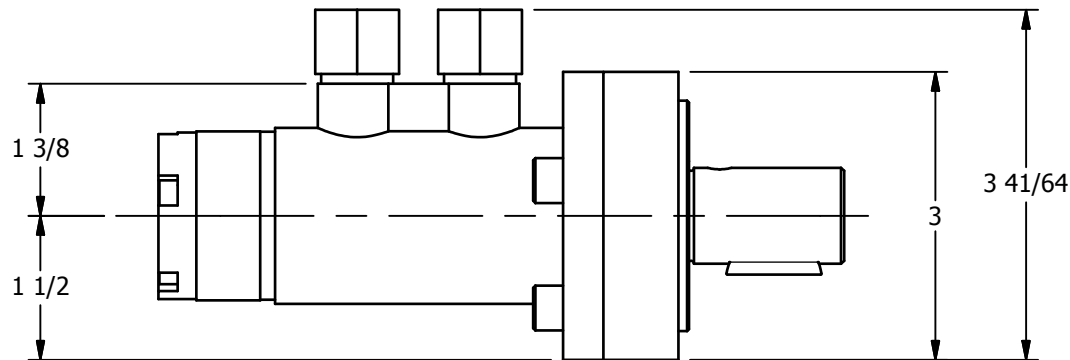

**AAA PRODUCTS
INTERNATIONAL**
7114 Harry Hines Blvd
Dallas, TX 75235

TITLE: A-SERIES MOTOR ASSEMBLY,
1.16 CU. IN. PER REV.,
JIFFY TAP & DRILL

DRAWING NO.:
DIM_A-2

2

4

1